

Installation Catalog

2025

Table of Contents

SUSPENSION & MOUNTING	2 - 7
TAPES, ADHESIVES, & HARDWARE	8 - 9
DUCTWORK & METAL	10 - 15
VENTILATION & EXHAUST	16 - 19
DEHUMIDIFIERS & ERVs	20 - 21
BATH, INLINE & ROOFTOP FANS	22 - 24
DUCT SMOKE DETECTION	25
GRILLES, REGISTERS & DIFFUSERS	26 - 27
CONDENSATE MANAGEMENT	28 - 30
PIPING, FITTINGS, & LINESETS	31 - 37
ELECTRICAL & WIRING	38 - 44
THERMOSTATS	45 - 49
ZONING	50 - 53
INDEX	54 - 56

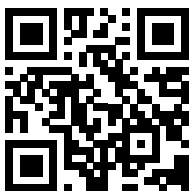

SCAN HERE
To Access Our Full
Catalog Selection

Strut Channel & Threaded Rod

Strut Channel

Item #	Gauge	Length	Dimensions
STRUT-DEEP-14G	14	10'	1-5/8" x 1-5/8" (Deep)
STRUT-DEEP-12G	12	10'	
STRUT-SHALLOW-14G	14	10'	13/16" x 1-5/8" (Shallow)



Threaded Rod

Item #	Length	Size	TPI (threads per inch)
ALLTHREAD-1/4-10	10'	1/4"	20
ALLTHREAD-3/8-06	6'	3/8"	16
ALLTHREAD-3/8-10	10'	3/8"	16
ALLTHREAD-1/2-10	10'	1/2"	13

Pipe Clamps

Item #	Size	Pack Qty.
CN04	1/4"	25 pk.
CN06	3/8"	
CN08	1/2"	
CN10	5/8"	
CN12	3/4"	
CN14	7/8"	
CN18	1-1/8"	20 pk.
CN22	1-3/8"	
CN26	1-5/8"	10 pk
CN34	2-1/8"	



Cush-A-Nator®
cush-a-clamps can retrofit/replace old clamps without raising the pipe.

Klo-Shure® insulation couplings support and secure the copper tube independent of the insulation. The insulation is then inserted into the coupling to provide a superior vapor barrier to other methods.



Copper Pipe Size	1/2" Wall Insulation Item #	3/4" Wall Insulation Item #	1" Wall Insulation Item #
1/4"	724025	726025	728025
3/8"	724037	726037	728037
1/2"	724050	726050	728050
5/8"	724062	726062	728062
3/4"	724075	726075	728075
7/8"	724087	726087	728087
1-1/8"	724112	726112	728112
1-3/8"	724137	726137	728137
1-5/8"	724162	726162	728162
2-1/8"	724212	726212	728212

Strut & Rod Hardware

Spring Nuts allow for placement anywhere within the channel. The spring holds the nut in the desired position until the rod or bolt is attached.

Item #	Thread Size
B2-4EG	1/4" - 20tpi
B2-6EG	3/8" - 16tpi
B2-8EG	1/2" - 13tpi



Square Washers facilitate a secure attachment on strut when combined with a channel nut, threaded rod, or other hardware.

Item #	Rod Size	Dimensions
B5052EG	1/4"	1-5/8"
B5053EG	3/8"	x
B5054EG	1/2"	1-5/8"

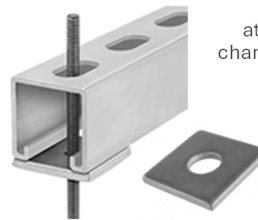

Hex Head Bolts

Item #	Length	Thread Size	Pack Qty.
MB381	1"		
MB38112	1.5"	3/8" 16tpi	100 pk
MB382	2"		



Hex Nuts

Item #	Thread Size	Pack Qty.
HN14	1/4" - 20tpi	100 pk.
HN38	3/8" - 16tpi	50 pk.
HN12	1/2" - 13tpi	25 pk.
339	Assortment	339 pc.



Rod Couplers

Item #	Thread Size	Pack Qty.
RC1	1/4" - 20tpi	100 pk.
RC2	3/8" - 16tpi	50 pk.
RC3	1/2" - 13tpi	50 pk.

Fender Washers

Item #	ID - OD	Pack Qty.
FENW316114	3/16" x 1-1/4"	
FENW382	3/8" x 2"	100 pk.
FENW122	1/2" x 2"	



Lock Washers

Item #	Size	Pack Qty.
LW14	1/4"	
LW38	3/8"	100 pk.
LW12	1/2"	



Flat Washers

Item #	ID - OD	Pack Qty.
FW14	5/16" x 3/4"	100 pk.
FW38	7/16" x 1"	100 pk.
FW12	9/16" x 1-3/8"	50 pk.
FW2	Assortment	421 pc.

Hanging Kits



Item #	Description	Contents
32059	Hanging Kit w/ 36" Strut & 15' Wire Rope	<ul style="list-style-type: none"> (2) 36" Strut Channel (4) 15' Wire Rope (4) Rod Hanging Anchors Hardware
TS3315SL4DW	3/8" Threaded Rod Suspension Hardware	<ul style="list-style-type: none"> (4) 15' Wire Rope (4) Rod Hanging Anchors Hardware

Strut & Rod Mounting

Splice Plates & Corners

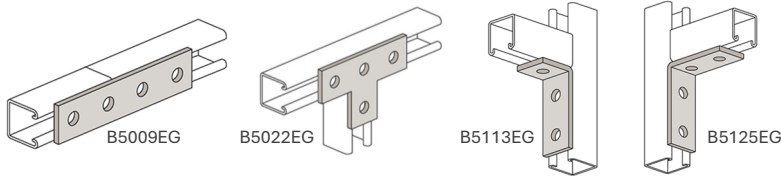

Splice Plates & Corners allow for easy connection of multiple pieces of strut channel together, or to attach strut to a wall or other surface.

Item #	Description
B5009EG	4-Hole Splice Plate
B5022EG	4-Hole Flat Tee Plate
B5113EG	3-Hole 90° Corner Angle
B5125EG	4-Hole 90° Corner Angle

Beam Clamps



Beam Clamps are used to join strut or threaded rod to I-beams, purlins, and other structural supports

Item #	Max Load	Rod Size	Height
BC9025EG	100 - 250 lbs.	1/4"	
BC800037EG	350 lbs.	3/8"	1.5"
BC800050EG	470 lbs.	1/2"	
BC810037EG	400 lbs.	3/8"	2"
BC810050EG	500 lbs.	1/2"	
B5709EG	1,200 lbs. (as a pair)	For both 1-5/8" and 13/16" strut	

Rod Hanging Anchors

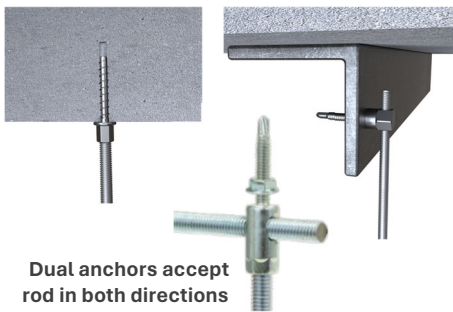

Rod Hanging Anchors are a female threaded rod receptacle that screws into wood, steel, or concrete. Dual direction (side and overhead) in wood and steel applications allow for quick and easy threaded rod installation in a variety of areas.



Item #	Direction	Application	Rod Size
SSW38D	Overhead & Side	Wood	
SSM38D	Overhead & Side	Steel	3/8"
SSC38B	Overhead Mount	Concrete	

Item #	Drive Socket Description
DUNIB	Socket for Dual Wood & Metal Rod Anchors
SCP38	Socket for 3/8" Concrete Rod Anchors

Rooftop Pipe & Strut Supports

The **Cush-A-Block** Rooftop Support is UV resistant and suitable for installation on most types of roofing material or other flat surfaces. 3/8" threaded rod (not included) or fasteners can be used to attach the included 10" section of 13/16" strut channel.

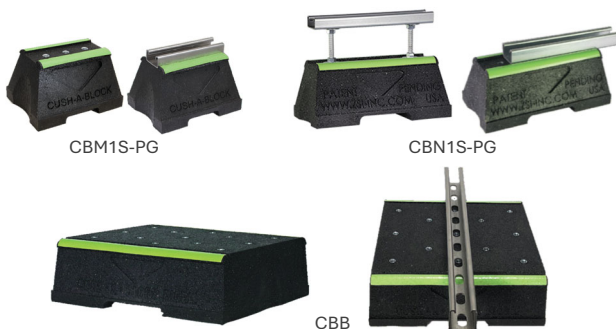

Item #	Style	Height	Height w/ Strut	Width	Strut Length	Total Length	Uniform Load lbs.	Fastener Size
CBM1S-PG	Mini	4"	4-5/8"	5"	5"	6-5/8"	400	
CBN1S-PG	Standard	4-3/16"	4-13/16"	5"	10"	10-1/2"	2,500	3/8" x 16tpi
CBB	Biggie	4-3/16"	-	12-1/2"	-	12-5/16"	7,500	

Suspended Vibration Isolators

Threaded Rod Disc Isolators

Item #	Max Load	Rod Size
AVHM-50	110 lbs.	3/8"
AVHM-100	220 lbs.	



AVHM Hanger Mount Series are an easier way to isolate vibration on suspended equipment. Now there is no need to cut threaded rod. Simply place these units under the strut or equipment. The elastomer element and rod collar reduces sound levels up to 17 dB (A).

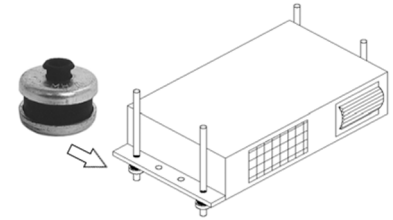

Threaded Rod Neoprene Isolators

Item #	Max Load	Height	Width	Depth
HND-A-3	70 lbs.			
HND-A-4	115 lbs.	3"	2"	2.25"

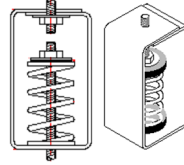
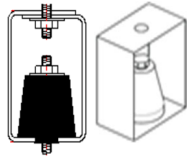

Threaded Rod Spring Isolators

Item #	Rated Load	Solid Load	Height	Width	Depth
HSF-044	76 lbs.	115 lbs.			
HSF-045	148 lbs.	222 lbs.	3.5"	1.5"	2.15"
HSA-124	173 lbs.	260 lbs.			
HSA-125	246 lbs.	370 lbs.	4.5"	2.25"	3"

Floor Mount Vibration Isolators

Floor Mount Neoprene Isolators

Item #	Max Load	Height	Width	Depth
FMD-A-3	70 lbs.			
FMD-A-4	115 lbs.	1.25"	3.13"	1.75"

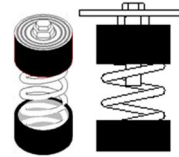
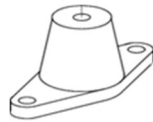

Free-Standing Spring Mount

Item #	Rated Load	Solid Load	Free Height	Width
BN-042	33 lbs.	50 lbs.		
BN-043	57 lbs.	86 lbs.	3.25"	1.5"

Floor-Mount Uncased Spring Isolators

Item #	Rated Load	Solid Load	Free Height	Width	Depth
BK-122	66 lbs.	100 lbs.			
BK-123	110 lbs.	165 lbs.	4"	4.5"	2.5"

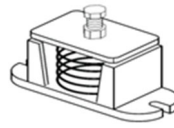
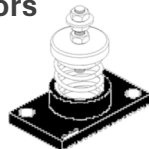

Floor-Mount Cased Spring Isolators

Item #	Rated Load	Solid Load	Free Height	Width	Depth
ZA-123	110 lbs.	165 lbs.			
ZA-124	173 lbs.	260 lbs.			
ZA-125	246 lbs.	370 lbs.	4.25"	4.25"	2.25"
ZA-126	300 lbs.	450 lbs.			

Vibration Pads

Item #	Size	Max. Load	Features
ISO-RUBBER-2"X2"X3/8"	2" x 2" x 3/8"	60 lbs.	Corrugated on both sides to reduce vibration, noise, as well as "creep" associated with vibration. The 18" x 18" sheets can be cut to any size.
ISO-RUBBER-18"X18"X3/8"	18" x 18" x 3/8"	per Sq. In.	
ISO-RUBBER-2"X2"X1"	2" x 2" x 1"	280 lbs.	Triple-Core™ design has different density layers to provide greater vibration and noise reduction. Excellent resistance to oil, water and ozone (recommended for outdoor use).
ISO-RUBBER-4"X4"X1"	4" x 4" x 1"	1,120 lbs.	
ISO-RUBBER-8"X8"X2"	8" x 8" x 2"	4,480 lbs.	

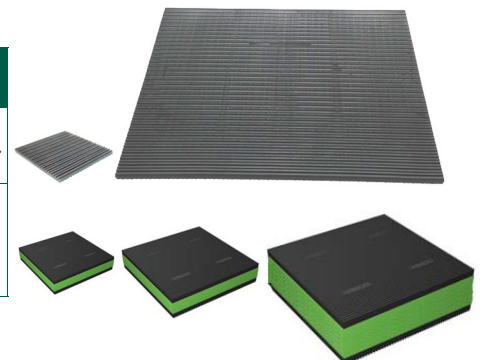

Drain Pans

Secondary Drain Pans with Welded Nipples

Type	Item #	Size	Application
TAM / TEM Air Handlers	PAN-32X60	32" x 60"	18,000 - 42,000 BTU Horizontal
	PAN-32X66	32" x 66"	48,000 - 60,000 BTU Horizontal
	PAN-32X36	32" x 36"	Vertical AHU Install

Type	Item #	Size	Application	Gauge
Dehumidifiers	PAN-18X44	18" x 44"	Honeywell DR65 / DR90 / DR120	22ga.
Slab Coils	PAN-18X44	18" x 44"	001 - 007 Slab Coils	
	PAN-24X48	24" x 48"	009 Slab Coils	
Box Coils	PAN-32X36	32" x 36"	002 - 007 & 145L - 175L Box Coils	
	PAN-32X40	32" x 40"	009 - 010 & 210L - 245L Box Coils	
	PAN-32X76	32" x 76"	Condensing Furnace + Box Coil	

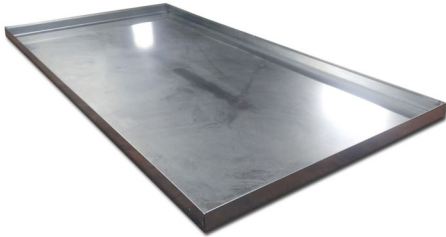

Type	Model	Vertical Install		Horizontal Install		Gauge
		Item #	Size	Item #	Size	
TWE Commercial Air Handlers	TWE060	PAN-32X48	32" x 48"	PAN-46X54	46" x 54"	22ga.
	TWE072 - TWE090	PAN-32X60	32" x 60"	PAN-56X60	56" x 60"	
	TWE120	PAN-32X76	32" x 76"	(2) PAN-30X72 (1) CLEAT-S-05	60" x 72" (Two 30" x 72" Pans Joined with S-Cleat)	
	TWE150 - TWE180	PAN-36X90	36" x 90"	(2) PAN-38X90 (1) CLEAT-S-10	76" x 90" (Two 38" x 90" Pans Joined with S-Cleat)	
	TWE240 - TWE300	PAN-40X100	40" x 100"	(2) PAN-40X100 (1) CLEAT-S-10	80" x 100" (Two 40" x 100" Pans Joined with S-Cleat)	

Horizontal Installation Supports



The Air Handler Block is a lightweight and cost effective base support for air handlers, coils, and furnaces. Raising the unit 4" provides air flow, and prevents damage from ground or secondary pan contact. It absorbs vibration and is strong enough to support most units.

Styrofoam Blocks

Item #	Size	Case Qty.
7-60	8" x 8" x 4"	144

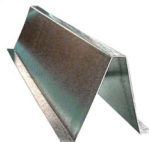

Furnace Stands and Bases provide a strong platform on which to set gas or electric units. The flange allows additional connection to floors or joists. The base secures the feet when sitting in a secondary drain pan.

Furnace Stands & Bases

Item #	Description	H x W x D	Gauge
FS-SMALL STAND	Small Size Stand	6" x 9" x 30"	20ga.
FS-SMALL BASE	Small Size Base	9" x 30"	26ga.
FS-LARGE STAND	Large Size Stand	9" x 11.5" x 30"	20ga.
FS-LARGE BASE	Large Size Base	11.5" x 30"	26ga.

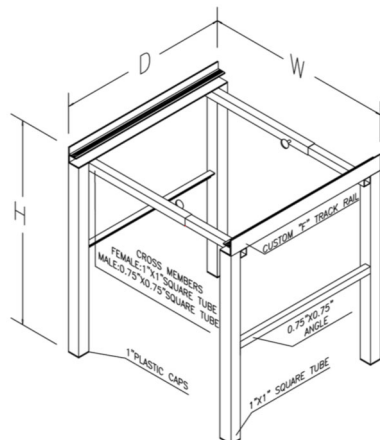

Adjustable Vertical Air Handler Stands

Adjustable Stands are perfect for free draw return air systems where the AHU is in a closet or other conditioned space. Or use ductboard to easily insulate around the stand for ducted returns. The built-in filter rack accommodates standard 1" filters.

Item #	Size	D	W	H	Material	Max
AHEB1722W	Standard - AHUs	22"	16" - 26"	17.5"	6061-T6 Extruded Aluminum	300 lbs.
AHEB1727W	Deep - Furnaces	27"				

Equipment Pads & Mounting Hardware

Condenser Pads

Type	Item #	Size	Application	Weight	Pallet Qty.
Polar Pad™	PAD-POLAR3636-3-B	36" x 36" x 3"	Small Unitary Condensers	16 lbs.	16
	PAD-POLAR4040-3-B	40" x 40" x 3"	Large Unitary Condensers	18.5 lbs.	16
UltraLite®	PAD-UC1838-3	18" x 38" x 3"	Small Ductless Condensers	20 lbs.	30
	PAD-UC2448-3	24" x 48" x 3"	Large Ductless Condensers	30 lbs.	15
	PAD-UC3636-3	36" x 36" x 3"	Small Unitary Condensers	30 lbs.	15
	PAD-UC4040-3	40" x 40" x 3"	Large Unitary Condensers	34 lbs.	15
Hurricane Pad™	PAD-H1840-4	18" x 40" x 4"	Ductless	62 lbs.	16
	PAD-H3636-4	36" x 36" x 4"	Small Unitary Condensers	100 lbs.	8
	PAD-H4040-4	40" x 40" x 4"	Large Unitary	140 lbs.	8
GenPad®	GENPAD-3	54" x 31" x 3"	8 - 26kW Generators	189 lbs.	5
	GENPAD-4	54" x 31" x 4"	Hurricane-Rated Applications	275 lbs.	5

PolarPad™ is a plastic pad made from polyethylene, so it is naturally stiffer without additives, and is resistant to cracking. It has large ribs that run in both directions for sturdy placement.

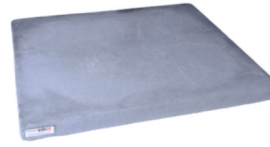

UltraLite® has a fiber-reinforced concrete outer skin and foam inner core, which allows the pad to flex instead of crack. The texture prevents sliding, and allows water drainage.

Designed for regions of the Gulf Coast, **The Hurricane Pad™** meets stringent requirements for wind resistance. Meets the Florida Building Code and can withstand winds up to 150 MPH.

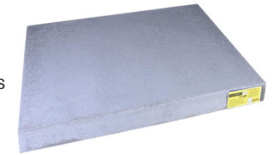

GenPad® is a composite pad with pre-drilled mounting holes. Fits Generac & Honeywell 8-26kW standby generators.

Tie Down Clips & Concrete Anchors

Item #	Description	Size	Qty.
TDC-4	12.ga. Tie-Down Clip	1" x 1" x 4"	4 pk.



Anchor Item #	Hex Size	Size W x L	Included Drill Bit	Pack Qty.
14H114	5/16"	1/4" x 1-1/4"	3/16"	100 pk.
14H134	5/16"	1/4" x 2-1/4"	3/16"	100 pk.
CK14	Concrete Anchor Assortment			60 pc.

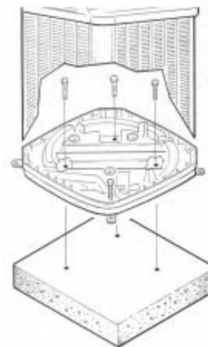

Trane "Extreme Condition" Mounts

These clips perfectly fit the pre-existing OEM slots in the Trane condenser base pad, providing a clean, "no show" finished look.



Item #	Fits	Qty.
BAYECMT023	Base 2 (29" x 26") Base 3 (33" x 30")	For 5 - 10 Units
BAYECMT004	Base 4 (37" x 34")	

Condenser Wall Mount Brackets

For Ductless Condensers

Item #	Features	Max Load	Dimensions
230-B3L	16ga. Powder-Coated Steel	500 lbs.	22" D x 15" H x 35" W



For Large Condensers

Item #	Bracket Length	Bracket Height	Outer Spacing	Inner Spacing	Max Unit Size	Max Load
AWB143036-WLR24	30"	36"	24"	14"	30" x 30"	
AWB143636-WLR30	36"	36"	30"	20"	38" x 36"	550 lbs.
AWB144836-WLR36	48"	36"	36"	15"	45" x 48"	



- 6061-T6 aluminum construction
- Rated for wind load up to 170 psf
- Original raised-seal engineering drawings can be ordered

Aluminum Equipment Stands

Aluminum Mechanical Unit Stands are engineered for use within hurricane zones (HVHZ - Miami-Dade County & Broward County). Carrying a Florida State Approval, these stands are available with optional cross-mounting angles, rubber boots, lead boots, and electrical mounting brackets.

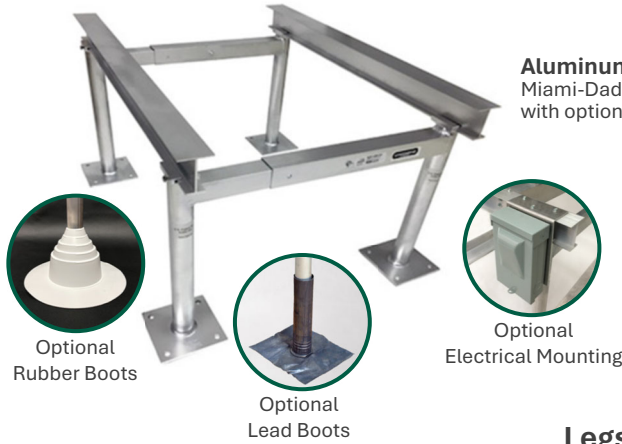

Legs: Minimum of (2) Required

Item #	Height	Adjustable Width
ASMUS18	18"	
ASMUS24	24"	20" - 30"
ASMUS30	30"	
ASMUH18	18"	
ASMUH24	24"	34" - 42"
ASMUH30	30"	

I-Beams: (2) Required

Item #	Length
ASI-3	3'
ASI-6	6'
ASI-9	9'
ASI-12	12'
ASI-15	15'
ASI-18	18'

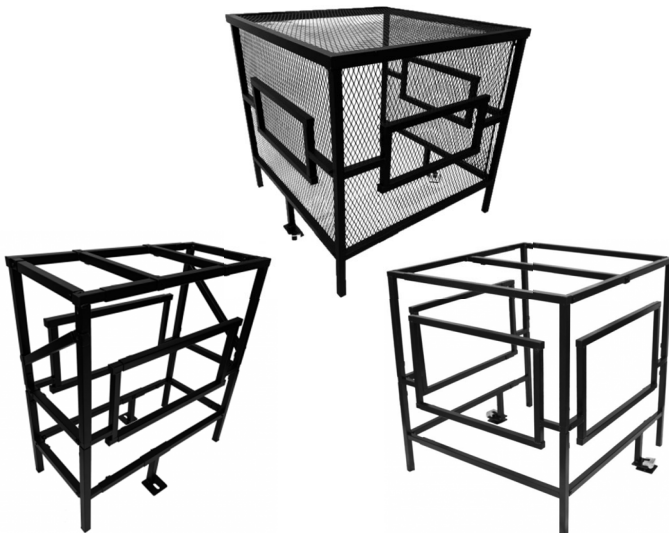
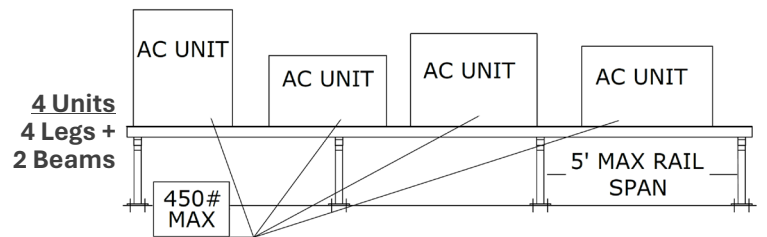
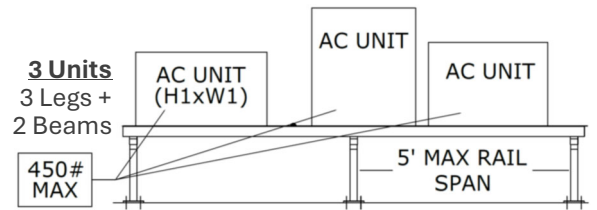
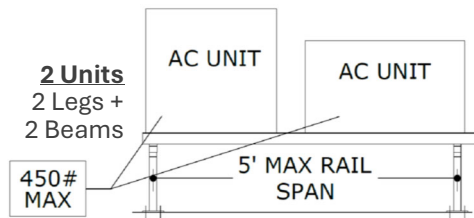
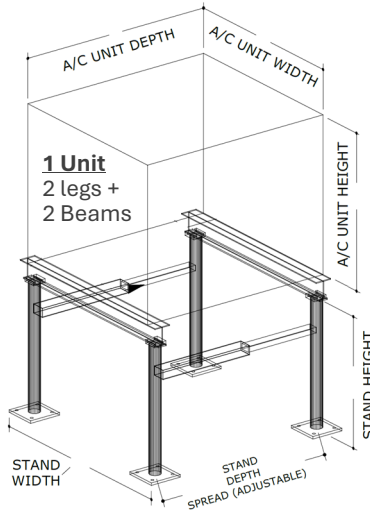

Condenser Security Cages

AC GUARD™ security cages prevent AC theft and unwanted access. They are made of 16 gauge steel, and are powder coated to resist rust and corrosion.

Adjustable and expandable to fit most AC units for commercial and residential applications. Mount AC Guard to concrete pads, or install with ground anchors.

Item #	Description	Width	Depth	Height
ACGUKIT	Large Cage w/ Top Lock & Bars	30" - 48"	30" - 48"	34" - 59"
ACMSKIT	Mini-Split Security Cage w/ Locks	32" - 45"	12" - 18"	23" - 57"
ACEM40	Expanded Metal Grating - 3pk.		40" x 40"	
ACEMS	Ductless Expanded Metal - 3pk.		24" x 30"	

Tapes

Metal Tapes

Item #	Size	Features	UL	Case Qty.
AF099-2.5	2.5" x 180'	Excellent Adhesion	UL 181A-P/B-FX	16
AF099-3	3" x 180'			
AF975	3" x 150'	Cold-Weather Adhesive	UL 723	16
AF984-3	3" x 150'	Scrim Reinforced	UL 723	16



Duct Sealing Tapes

Item #	Size	Case Qty.	Color	UL
DC181-2MPT	2" x 360'	24	Sliver	UL 181B-FX
DC181-3MPT	3" x 360'	16		

DC181 Flex Fix is for connecting, sealing, and patching flex duct. It is printed with the UL Listing to ensure every job is code compliant. It has excellent conformability to uneven surfaces, is easy to unwind and tear, and the color matches flex duct.

Lineset Tapes & Adhesives

Item #	Description	Size	Color	Case Qty.
326381	TPO Line Set Wrap	9" x 75'	White	4
VP410	Line Set Tape	2" x 100'	Black	24
INS-GLUE-08	Armocell Adhesive	1/2 pt.	Gold	48



TPO Rolled Mastic Sealant is a membrane that provides UV protection and a white impact resistant surface for lineset protection.

VP410 is a UV-resistant SPVC tape used to wrap line sets, and seal the seams on closed cell sponge insulation.

Insulation & Curb Gasket Tapes

Item #	Type	Size	Case Qty.
6-330	Cork	1/8" x 2" x 30'	12
6-9718	Foam	1/8" x 2" x 30'	40
T1070	Curb Gasket	1/4" X 1" x 25'	Each



Waterproof Repair Tapes

Item #	Brand	Dimensions
285987	T-REX®	4" x 5'

T-Rex® Waterproof Tape adheres under dry or wet conditions, even underwater. Use it to temporarily stop a leak in a water pipe or pan.



Electric Tapes

Item #	Description	Size	Case Qty.
EV77B	Shurtape	3/4" x 66'	10
ET33	3M Super 33+		



Utility & Duct Tapes

Type	Item #	Color	Dimensions	Case Qty.
Utility Duct Tape	PC609-B	Black	2" x 180'	24
	PC609-S	Silver	3" x 180'	
UL 181B-FX Duct Tape	PC857-BPT	Black	2" x 180'	24
	PC857-SMT	Silver	2" x 180'	
T-REX® Duct Tape	242974	Black	2" x 90'	6
	152506	Orange	2" x 105'	
Caution Tape	232531	Yellow	3" x 100'	16
Teflon Tape	6-733	White	1/2"	Each
Gas Line Tape	31403D	Yellow	1/2"	20
Masking Tape	202880	Blue	2" x 180'	24

Mastics

Duct Sealants

Item #	Color	Application	Size
CADS-1-B	Black	Standard Ductwork - Up to 10" WC	1 gal.
CADS-1-G	Gray		
CADS-1-W	White		
AIRSEAL 11	Gray	Commercial Ductwork - Up to 16" WC	1 gal.

CADS is a fiber reinforced, water-based, duct sealant used to pressure seal all types of HVAC systems including metal and flex duct.



Airseal 11 is a premium water-based duct sealant providing commercial-grade strength. Exceptional flexibility and adhesion, with a high solids formulations.



Foil-Grip Mastic Tapes

Item #	Mfg. #	UL	Color	Size	Case Qty.
AFG-1402	304100	-	Silver	3" x 100'	16
AFG-1404	325804	UL 181B-FX			



Foil-Grip is a pressure sensitive duct joint and general purpose rolled sealant. It has superior tack for instant grab strength to galvanized metal, flex duct, PVC coated pipe, and PVC coated ductwork for an immediate airtight bond.

Mastic Brushes

Item #	Size	Case Qty.
B-503	2"	24
B-505	3"	12



Adhesives

Firestop Caulk & Construction Adhesive

Item #	Description	Color	Size	Case Qty.
81410	Intumescent Firestop Caulk	Red	10.1 oz.	12
12503	Construction Adhesive	Gray	9.5 oz.	12
24110	Roof Cement	Black	10.1 oz.	12
7-200	Caulk Gun			



Silicone & Latex Caulk

Desc.	Item #	Color	Size	Case Qty.
Silicone Sealant Caulk	38000	Clear	9.5 oz. Tube	12
	38001	White		
	38003	Aluminum		
	37008	Clear	8 oz. Pressurized Can	
	37081	White		
Latex Caulk	35701	White	9.5 oz. Tube	12

Spray Foams & Adhesive Aerosols



Item #	Size	Case Qty.	Description	Application Notes
635C10	12 oz.	12	Low-VOC Spray Adhesive	Fast tack, high bond insulation spray adhesive
33316	12 oz. w/ Straw	12	Multi-Purpose Polyurethane Spray Foam	Expands to 3X its original volume
33320	20 oz. Genius Gun®	12		
81212	12 oz. w/ Straw	12	Fire Block Spray Foam	Meets UL 723, ASTM E-84 and NFPA 255 Class A
323822	14 oz.	12	Insulation Edge Sealer	Encapsulates cut ends of insulation and ductwork. Ideal for spot repair.

Additional Hardware & Fasteners from



Sheet Metal Screws - Taper Point

Head Size	Length	100 Pack Item #	Bulk Pack Item #	Qty.
#8 (1/4" Hex)	1/2"	SP812	SPT812	500 pk.
	3/4"	SP834	SPT834	500 pk.
	1"	SP81	SPT81	500 pk.
	2"	SP82	SPT82	200 pk.
#10 (5/16" Hex)	1/2"	SP1012	SPT1012	500 pk.
	3/4"	SP1034	SPT1034	500 pk.
	1"	SP101	SPT101	400 pk.



Sheet Metal Screws - Self Tapping

Head Size	Length	100 Pack Item #	Bulk Pack Item #	Qty.
#8 (1/4" Hex)	1/2"	TEKHW812	TEKHT812	500 pk.
	3/4"	TEKHW834	TEKHT834	500 pk.
	1"	TEKHW81	TEKHT81	500 pk.
#10 (5/16" Hex)	1/2"	TEKHW1012	TEKHT1012	500 pk.
	3/4"	TEKHW1034	TEKHT1034	500 pk.
	1"	TEKHW101	TEKHT101	400 pk.
#12 (5/16")	1"	TEKHW121		
#14 (3/8")	1"	TEKHW141		



White Register Screws - Taper Point

Head Size	Length	100 Pack Item #	Bulk Pack Item #	Qty.
#8 (1/4" Hex)	1-1/2"	SPR8112	SPRT8112	300 pk.
	2"	SPR82	SPRT82	200 pk.

Wood / Drywall Screws

Item #	Size	Type	Pack Qty.
DWSBX6158	#6 x 1-5/8"	Black Oxide	100 pk.
WR6114	#6 x 1-1/4"	Carbon Steel w/ Zinc Coating	100 pk.
WR6158	#6 x 1-5/8"		
WR83	#8 x 3"		
WR6	Steel/Zinc #6 Coarse Thread Assortment		



Anchor Kits

Item #	Screw Size	Anchor Type	Included Drill Bit	Qty.
RD3HX	#8 x 1" Hex/Slotted			
K6HX	#10 x 1" Hex/Slotted	Red Collar	1/4" Carbide	100 pc.
K14CHX	#12 x 1-1/2" Hex/Slotted			
WDK8	#8 x 1-1/4" Phillips/Slotted	Zinc Driller	#2 Phillips Bit	50 pc.
WTKHX	#10 x 1-1/4" Hex/Slotted	Wall Twister	3/16" Carbide	100 pc.
FTG14	1/4" x 2-1/2" Phillips/Slotted	Flip Toggle	-	10 pc.



Flexible Duct from JPL

JPL's Silver Jacket flex is constructed with a spring steel wire helix, encapsulated in a 2-ply, air-tight inner core - UL-181 Class 1 Air Duct. 3/8" oversized inner core for ease of install. GREENGUARD Gold Certification.



AMBlue II Anti-Microbial flexible duct has a core treated with Agion® natural silver to resist microbial growth. GREENGUARD Indoor IAQ Certified as "Highly Mold Resistant."



Mobile Home Flex has an extra heavy-duty, UV-inhibited polyethylene vapor barrier for outdoor use with mobile homes.



Silver Flexible Duct - 25' Bags

Size	R6	R6 Pallet Qty.	R8	R8 Pallet Qty.
4"	FLEX-R6-04	144	FLEX-R8-04	75
5"	FLEX-R6-05	100	FLEX-R8-05	100
6"	FLEX-R6-06	100	FLEX-R8-06	80
7"	FLEX-R6-07	80	FLEX-R8-07	64
8"	FLEX-R6-08	64	FLEX-R8-08	64
9"	FLEX-R6-09	64	FLEX-R8-09	48
10"	FLEX-R6-10	48	FLEX-R8-10	48
12"	FLEX-R6-12	36	FLEX-R8-12	36
14"	FLEX-R6-14	36	FLEX-R8-14	24
16"	FLEX-R6-16	24	FLEX-R8-16	16
18"	FLEX-R6-18	16	FLEX-R8-18	16
20"	FLEX-R6-20	16	FLEX-R8-20	16

Antimicrobial - 25' Boxes

Size	R8 Antimicrobial	Pallet Qty.
4"	FLEX-R8-AMB-04	75
5"	FLEX-R8-AMB-05	100
6"	FLEX-R8-AMB-06	80
7"	FLEX-R8-AMB-07	64
8"	FLEX-R8-AMB-08	64
9"	FLEX-R8-AMB-09	48
10"	FLEX-R8-AMB-10	48
12"	FLEX-R8-AMB-12	36
14"	FLEX-R8-AMB-14	24
16"	FLEX-R8-AMB-16	16
18"	FLEX-R8-AMB-18	16
20"	FLEX-R8-AMB-20	16

Mobile Home - 25' Boxes

Size	R8 Mobile Home	Pallet Qty.
6"	FLEX-R8-MOBILE-06	80
8"	FLEX-R8-MOBILE-08	64
10"	FLEX-R8-MOBILE-10	48
12"	FLEX-R8-MOBILE-12	36
14"	FLEX-R8-MOBILE-14	24
16"	FLEX-R8-MOBILE-16	16

Ductboard, Liner & Wrap

Item #	Size	Insulation	Mfg. #	Boards Per Pallet
DUCTBOARD-R4.2-SHEET	1" x 4' x 10'	R4.2 (475)	441732	48
DUCTBOARD-R6-SHEET	1.5" x 4' x 10'	R6 (800)	441743	32
DUCTBOARD-R8-SHEET	2" x 4' x 10'	R8 (1400)	441745	24



Owens Corning® QuietR® Duct Board is bacterial and fungal growth resistant with an EPA registered biocide to help protect the air stream surface from microbial growth.

Duct Liner

Item #	Mfg. #	Dimensions	Insulation
DUCTLINER-1.5X48X50	634466	1.5" x 48" x 50'	R6
DUCTLINER-2X48X50	634831	2" x 48" x 50'	R8

Owens Corning® QuietR® Duct Liner is installed inside sheet metal ductwork or plenums with metal fasteners and adhesives.



Duct Wrap

Item #	Mfg. #	Dimensions	Insulation
DUCTWRAP-2.2X48X75	670734	2.2" x 48" x 75'	R6
DUCTWRAP-3X48X50	634831	3" x 48" x 50'	R8



Owens Corning® SOFTR® Duct Wrap blanket-type fiberglass insulation is used to provide exterior insulation on ductwork.

Outward Clinch Staple Gun & Stapler

Item #	Description
T50MOC	T50MOC Outward Clinch Staple Gun
509	9/16" Leg Staples for T50 Staple Guns - 1,250 Count



Outward clinch staplers are used for insulation because they create a secure grip on paper and facings. The staples bend outward, allowing them to penetrate the paper while leaving the fiberglass underneath intact.

Triangles & Mixing Boxes

R6 Ductboard Mixing Boxes

Item #	Size
MIXINGBOX-16X16X24	16" x 16" x 24"
MIXINGBOX-20X20X24	20" x 20" x 24"



Mixing boxes are pre-assembled & taped

R6 Ductboard Triangles

Item #	Size
TRIANGLE-12X12X12	12" x 12" x 12"
TRIANGLE-16X16X16	16" x 16" x 16"
TRIANGLE-18X18X24	18" x 18" x 24"

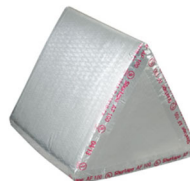

Triangles are pre-assembled & taped

Attic Insulation

Blown-In Loose Fill Insulation



ProCat® machine Available for Rent!



543516

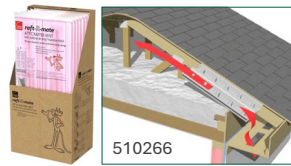

510266



LOOSE FILL INSULATION

Item #	Description	Case / Pallet Qty.
LOOSE FILL INSULATION	ProCat® 33.5 lb. Insulation Bag	33
510266	raft-R-mate® Ventilation Baffles for Soffit Vents	75
543516	SmartCap® Attic Recessed Light Cover	50

Attic Tent® Insulated Access Covers



The Attic Tent® creates an air transfer barrier between the attic and living areas. It is designed to stop air infiltration between the home and attic, the most common medium for wasting costly home energy.

Item #	Dimensions
AT-1	22" x 54" x 7"
AT-2	25" x 54" x 7"
AT-4	25" x 54" x 13"
AT-5	30" x 60" x 13"

Duct Hanging & Fastening

Metal Strap

Item #	Gauge	Width	Length
STRAP-PERFORATED-3/4"	28ga.	3/4"	100'
STRAP-METAL-1"	26ga.	1"	100'
STRAP-METAL-1.5"	26ga.	1.5"	100'



Nylon Webbed Strap

Item #	Color	Width	Length
STRAP-WEBBED-1.75" BLACK	Black	1-3/4"	300'
STRAP-WEBBED-1.75" SILVER	Silver		
STRAP-WEBBED-3" BLACK	Black	3"	300'
STRAP-WEBBED-3" SILVER	Silver		

Duct Saddles

Item #	Description	Case Qty.
DS3	12" Duct Saddle	200 pc.



The average duct system is only 57% efficient; use the **Duct Saddle** to stop kinking and sagging to improve ductwork airflow. This 12" saddle works with all types of strap - metal and webbed.

Duct Cable Ties

Item #	Length	Pack Qty.
36 IN DUCT TIES	36"	50pk.
48 IN DUCT TIES	48"	

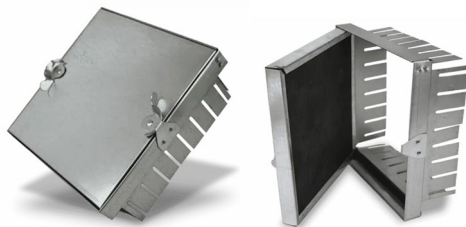

Duct Board Access Doors with tab lock frame are used to access the inside of rectangular ductwork. Works in 1", 1½" and 2" duct board applications.

Duct Access Doors

Item #	Size	Gauge	Qty.
ACCESSDOOR-08	8" x 8"	28ga.	6
ACCESSDOOR-10	10" x 10"	26ga.	6

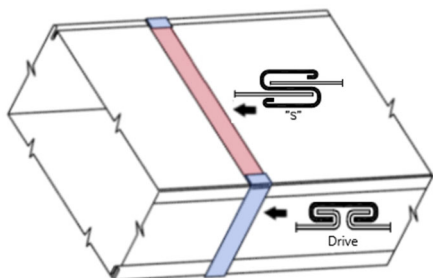

Drive and "Flat S" Cleat - are the standard means of connecting two rectangular duct sections end-to-end. The Flat S is used on the bottom and top of duct (the long side) and the Drive Cleat is used on the left and right sides (the short side).



Item #	Length	Gauge	Qty.
CLEAT-DRIVE-05	5'	26ga.	10
CLEAT-DRIVE-10	10'	26ga.	10
CLEAT-S-05	5'	26ga.	10
CLEAT-S-10	10'	26ga.	10

OEM-Matched Supply & Return Plenums

OEM Matched R6 Metal Return Plenums

Furnace or AHU	Cabinet Width	Height x Depth	Item #	Length
S8 & S9 Trane Furnace	A	13" x 20"	PLENUM-RET-13X20X2	2'
			PLENUM-RET-13X20X3	3'
	B	16" x 20"	PLENUM-RET-16X20X2	2'
			PLENUM-RET-16X20X3	3'
	C	20" x 20"	PLENUM-RET-20X20X2	2'
			PLENUM-RET-20X20X3	3'
	D	20" x 23"	PLENUM-RET-20X23X2	2'
			PLENUM-RET-20X23X3	3'
TEM Series AHUs	18.5"	17" x 19"	PLENUM-RET-17X19X2	2'
			PLENUM-RET-17X19X3	3'
	23.5"	19" x 22"	PLENUM-RET-19X22X2	2'
			PLENUM-RET-19X22X3	3'
TAM Series AHUs	17.5"	15" x 18"	PLENUM-RET-15X18X2	2'
			PLENUM-RET-15X18X3	3'
	21.3"	18" x 19"	PLENUM-RET-18X19X2	2'
			PLENUM-RET-18X19X3	3'
	23.5"	18" x 21"	PLENUM-RET-18X21X2	2'
			PLENUM-RET-18X21X3	3'



Plenums are capped on one end. They are boxed "knocked down" for ease of transport, and are ready to field assemble.

OEM Matched R8 Metal Supply Plenums

Coil or AHU	Cabinet Width	Height x Depth	Item #	Length
5TXC & Aspen DE	A 145L	14" x 20"	PLENUM-SUP-14X20X3	3'
			PLENUM-SUP-14X20X4	4'
	B 175L	17" x 20"	PLENUM-SUP-17X20X3	3'
			PLENUM-SUP-17X20X4	4'
	C 210L	20" x 20"	PLENUM-SUP-20X20X3	3'
			PLENUM-SUP-20X20X4	4'
	D 245L	20" x 24"	PLENUM-SUP-20X24X3	3'
			PLENUM-SUP-20X24X4	4'
5PXFH Slab Coils	001	21" x 24"	PLENUM-SUP-21X24X3	3'
	003-5-7	21" x 30"	PLENUM-SUP-21X30X3	3'
	009	27" x 34"	PLENUM-SUP-27X34X3	3'
TEM Series AHUs	18.5"	13" x 17"	PLENUM-SUP-13X17X3	3'
			PLENUM-SUP-13X17X4	4'
	23.5"	13" x 22"	PLENUM-SUP-13X22X3	3'
			PLENUM-SUP-13X22X4	4'
TAM & GAM Series AHUs	17.5"	15" x 15"	PLENUM-SUP-15X15X3	3'
			PLENUM-SUP-15X15X4	4'
	21.3"	15" x 19"	PLENUM-SUP-15X19X3	3'
			PLENUM-SUP-15X19X4	4'
	23.5"	15" x 21"	PLENUM-SUP-15X21X3	3'
			PLENUM-SUP-15X21X4	4'

Filter Box & Standard Size Return Plenums

Item #	Length	Fits Honeywell Filter Cabinet	Fits Apritair Filter Cabinet	Height x Depth
PLENUM-RET-16X20X2	2'	F1001620	1110	16" x 20"
PLENUM-RET-16X20X3	3'			
PLENUM-RET-16X25X2	2'	F100F1625	1410, 2410, 2416	16" x 25"
PLENUM-RET-16X25X3	3'			
PLENUM-RET-20X20X2	2'	F100F2020	1310, 2310	20" x 20"
PLENUM-RET-20X20X3	3'			
PLENUM-RET-20X25X2	2'	F100F2025	1210, 1910	20" x 25"
PLENUM-RET-20X25X3	3'	F100F2044	2210, 2216	
PLENUM-RET-28X31X2	2'	-	1510, 2516	28" x 31"
PLENUM-RET-28X31X3	3'			
PLENUM-RET-20X30X2	2'	For Central Returns		20" x 30"
PLENUM-RET-20X30X3	3'			

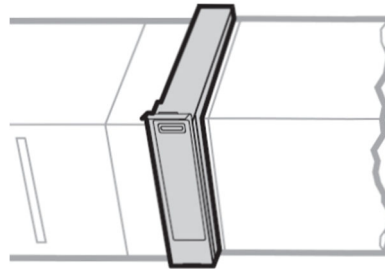

Filter Box Return Plenums are designed to make a return duct connection to popular wholesale media air filter cabinets.

Filter Box to Furnace Return Transitions

S8 & S9 Furnace Width	Filter Box Nominal Size	Item #	Furnace Opening Dimensions	Filter Box Opening Dimensions	Transition Length
A	16" x 25"	TRANSITION-13X20-15X24	13" x 20"	15" x 24"	10"
	B	16" x 25"	TRANSITION-16X20-15X24	16" x 20"	
20" x 25"		TRANSITION-16X20-19X24	16" x 20"	19" x 24"	
C	20" x 25"	TRANSITION-20X20-19X24	20" x 20"	19" x 24"	
	28" x 31"	TRANSITION-20X20-19X24	20" x 20"	24" x 29"	

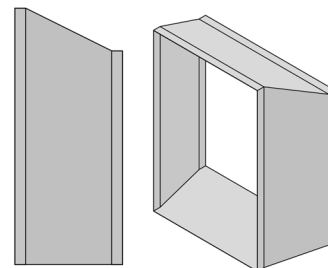

Furnace to Coil Transitions

OEM Furnace to Box Coil Insulated Transitions

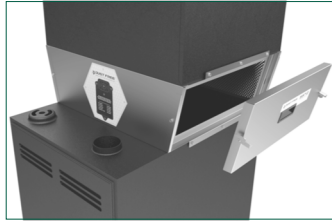
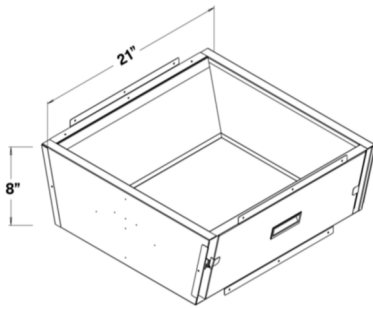

S8 & S9 Furnace Width	5TXC & Aspen DE Coil Width	Item #	Furnace Opening Dimensions	Coil Opening Dimensions	Transition Length
A	A & 145L	SST-AA	14" x 21"	14.25" x 21"	8"
	B & 175L	SST-AB	14.25" x 21"	17.75" x 21"	
B	B & 175L	SST-BB	17.5" x 21"	17.75" x 21"	
	C & 210L	SST-BC	17.75" x 21"	21.25" x 21"	
C	D & 245L	SST-BD	17.75" x 21"	24.75" x 21"	
	C & 210L	SST-CC	21" x 21"	21.25" x 21"	
D	D & 245L	SST-CD	21.25" x 21"	24.75" x 21"	
	D & 245L	SST-DD	24.5" x 21"	24.75" x 21"	

OEM Furnace to Slab Coil Insulated Transitions

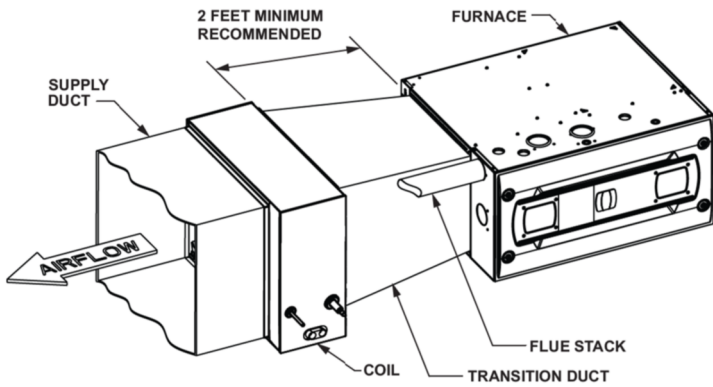

S8 & S9 Furnace Width	4PXFH Coil Model	Item #	Furnace Opening	Coil Opening	Transition Length
A	001	TRANSITION-14X21-21X24	14" x 21"	21" x 24"	2'
	003-007	TRANSITION-14X21-21X30	14" x 21"	21" x 30"	
B	001	TRANSITION-17X21-21X24	17" x 21"	21" x 24"	
	003-007	TRANSITION-17X21-21X30	17" x 21"	21" x 30"	
C	009	TRANSITION-17X21-27X34	17" x 21"	27" x 34"	
	003-007	TRANSITION-21X21-21X30	21" x 21"	21" x 30"	
D	009	TRANSITION-21X21-27X34	21" x 21"	27" x 34"	
	009	TRANSITION-24X21-27X34	24" x 21"	27" x 34"	

DucTite® R6 Register Box w/ Collar & Bootrail Flange

Grille Size	Collar Size	Item #	Case Qty.
8" x 4"	4"	602R6844	40
8" x 8"	6"	602R6886	20
10" x 6"	5"	602R61065	27
	6"	602R61066	27
10" x 8"	6"	602R61086	24
	7"	602R61087	24
10" x 10"	8"	602R61088	24
	7"	602R610107	16
10" x 10"	8"	602R610108	16
	9"	602R610109	16
12" x 12"	9"	602R612129	12
	10"	602R6121210	12



Register Boxes

Metal R6 Supply Register Box w/ Collar & Damper - 4" Tall

Grille Size	Collar Size	Item #	Case Qty.
8" x 4"	4"	BOX-0804-04-D	42
	5"	BOX-0804-05-D	24
10" x 6"	5"	BOX-1006-05-D	25
	6"	BOX-1006-06-D	25
10" x 8"	7"	BOX-1006-07-D	20
	6"	BOX-1008-06-D	12
10" x 8"	7"	BOX-1008-07-D	18
	8"	BOX-1008-08-D	12
10" x 10"	7"	BOX-1010-07-D	14
	8"	BOX-1010-08-D	14
12" x 6"	6"	BOX-1206-06-D	24
	7"	BOX-1206-07-D	20
12" x 8"	8"	BOX-1206-08-D	20
	8"	BOX-1208-08-D	14
12" x 8"	9"	BOX-1208-09-D	12
	8"	BOX-1212-08-D	10
12" x 12"	9"	BOX-1212-09-D	10
	10"	BOX-1212-10-D	10

Boostrail

Boostrail is a metal strip used to attach the register box to a joist, providing a stable mounting base.

Item #	Length	Application	Case Qty.
MP-SOR	25"	Flanged Boxes	60
BOOTRAIL-L	26"	Non-Flanged Boxes	50



“No Hole” Register Boxes

“No Hole” Return Box: Metal Sides with Ductboard Flat Top - 6” Tall

Item #	Grille Size
BOX-1224-DB	12" x 24"
BOX-1425-DB	14" x 25"
BOX-1625-DB	16" x 25"
BOX-2020-DB	20" x 20"
BOX-2025-DB	20" x 25"
BOX-2030-DB	20" x 30"

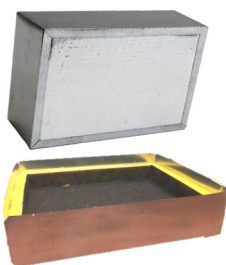

Ductboard Top Return Boxes allow for quick installation of a top-mounted ductboard collar. The opening of the box is “blade edge” with no flange.

“No Hole” Supply-Return Box: Metal Sides w/ Flat Top - 9” Tall

Item #	Grille Size	Case Qty.
BOX-0804	8" x 4"	24
BOX-0808	8" x 8"	12
BOX-1006	10" x 6"	16
BOX-1008	10" x 8"	8
BOX-1010	10" x 10"	10
BOX-1206	12" x 6"	12
BOX-1208	12" x 8"	8
BOX-1212	12" x 12"	6
BOX-1406	14" X 6"	12
BOX-1408	14" X 8"	8



No-Hole Boxes allow for quick field installation of a ductboard collar - either out of the side or the top. The downward facing internal flange is ideal for attaching supply or return grilles.

Collars

Pre-Assembled Snapped Collars w/ Damper - 30ga.

Item #	Duct Size	Case Qty.
COLLAR-SN-04-D	4"	40
COLLAR-SN-05-D	5"	32
COLLAR-SN-06-D	6"	48
COLLAR-SN-07-D	7"	40
COLLAR-SN-08-D	8"	32
COLLAR-SN-09-D	9"	24
COLLAR-SN-10-D	10"	20
COLLAR-SN-12-D	12"	12
COLLAR-SN-14-D	14"	12
No Damper Models		
COLLAR-SN-16	16"	7
COLLAR-SN-18	18"	7
COLLAR-SN-20	20"	6

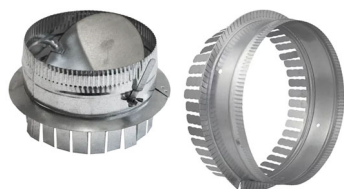

Unsnapped (Nested) Collars - 30ga.

Item #	Duct Size	Case Qty.
COLLAR-UN-04	4"	20
COLLAR-UN-05	5"	20
COLLAR-UN-06	6"	20
COLLAR-UN-07	7"	20
COLLAR-UN-08	8"	20
COLLAR-UN-09	9"	20
COLLAR-UN-10	10"	20
COLLAR-UN-12	12"	20
COLLAR-UN-14	14"	20
COLLAR-UN-16	16"	20
COLLAR-UN-18	18"	20

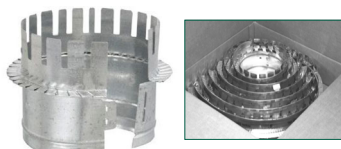

Heavy-Duty 24ga. Press-On Collar w/ Damper

Item #	Duct Size	Case Qty.
COLLAR-PR-04-D	4"	24
COLLAR-PR-05-D	5"	20
COLLAR-PR-06-D	6"	20
COLLAR-PR-07-D	7"	18
COLLAR-PR-08-D	8"	22
COLLAR-PR-09-D	9"	20
COLLAR-PR-10-D	10"	16
COLLAR-PR-12-D	12"	16
COLLAR-PR-14-D	14"	12
No Damper Models		
COLLAR-PR-16	16"	8
COLLAR-PR-18	18"	8
COLLAR-PR-20	20"	8



Dampers & Flex Connectors

Round Dampers - 26ga.

Item #	Duct Size	Case Qty.
DAMPER-04	4"	50
DAMPER-05	5"	50
DAMPER-06	6"	50
DAMPER-07	7"	50
DAMPER-08	8"	50
DAMPER-09	9"	50
DAMPER-10	10"	50
DAMPER-12	12"	25
DAMPER-14	14"	25
DAMPER-16	16"	25
DAMPER-18	18"	25
DAMPER-20	20"	25



Flex Duct Connectors

Item #	Duct Size	Case Qty.
CONNECTOR-04	4"	20
CONNECTOR-05	5"	20
CONNECTOR-06	6"	20
CONNECTOR-07	7"	20
CONNECTOR-08	8"	20
CONNECTOR-09	9"	20
CONNECTOR-10	10"	20
CONNECTOR-12	12"	20
CONNECTOR-14	14"	20
CONNECTOR-16	16"	20
CONNECTOR-18	18"	20
CONNECTOR-20	20"	20

Reducers



Item #	Duct Size	Case Qty.
REDUCER-0403	4" x 3"	12
REDUCER-0504	5" x 4"	12
REDUCER-0604	6" x 4"	12
REDUCER-0605	6" x 5"	12
REDUCER-0705	7" x 5"	12
REDUCER-0706	7" x 6"	12

Item #	Duct Size	Case Qty.
REDUCER-0806	8" x 6"	12
REDUCER-0807	8" x 7"	12
REDUCER-0907	9" x 7"	6
REDUCER-0908	9" x 8"	6
REDUCER-1008	10" x 8"	6
REDUCER-1009	10" x 9"	6

Item #	Duct Size	Case Qty.
REDUCER-1210	12" x 10"	6
REDUCER-1412	14" x 12"	6
REDUCER-1614	16" x 14"	6
REDUCER-1816	18" x 16"	1
REDUCER-2018	20" x 18"	1

Wyes



Item #	Duct Size	Case Qty.
WYE-04-03-03	4" x 3" x 3"	50
WYE-05-04-04	5" x 4" x 4"	30
WYE-06-04-04	6" x 4" x 4"	30
WYE-06-05-05	6" x 5" x 5"	28
WYE-07-05-05	7" x 5" x 5"	24
WYE-07-06-04	7" x 6" x 4"	20
WYE-07-06-05	7" x 6" x 5"	20
WYE-08-06-05	8" x 6" x 5"	16
WYE-08-06-06	8" x 6" x 6"	16

Item #	Duct Size	Case Qty.
WYE-08-07-04	8" x 7" x 4"	16
WYE-08-07-05	8" x 7" x 5"	16
WYE-08-07-06	8" x 7" x 6"	14
WYE-09-07-05	9" x 7" x 5"	12
WYE-09-07-06	9" x 7" x 6"	12
WYE-09-07-07	9" x 7" x 7"	12
WYE-09-08-06	9" x 8" x 6"	12
WYE-09-08-07	9" x 8" x 7"	10
WYE-10-08-06	10" x 8" x 6"	10
WYE-10-08-07	10" x 8" x 7"	8

Item #	Duct Size	Case Qty.
WYE-10-08-08	10" x 8" x 8"	8
WYE-10-09-06	10" x 9" x 6"	10
WYE-10-09-07	10" x 9" x 7"	8
WYE-10-09-08	10" x 9" x 8"	8
WYE-12-09-08	12" x 9" x 8"	6
WYE-12-09-09	12" x 9" x 9"	5
WYE-12-10-08	12" x 10" x 8"	6
WYE-12-10-10	12" x 10" x 10"	4
WYE-14-12-10	14" x 12" x 10"	2
WYE-14-12-12	14" x 12" x 12"	2

Snaplock Pipe



Item #	Duct Size	Length	Gauge	Bundle Qty.
SNAPLOCK-04	4"	5'	30 ga.	10
SNAPLOCK-05	5"	5'	30 ga.	10
SNAPLOCK-06	6"	5'	30 ga.	10
SNAPLOCK-07	7"	5'	30 ga.	10
SNAPLOCK-08	8"	5'	30 ga.	10
SNAPLOCK-09	9"	5'	30 ga.	10
SNAPLOCK-10	10"	5'	30 ga.	10

Item #	Duct Size	Length	Gauge	Bundle Qty.
SNAPLOCK-12	12"	5'	28 ga.	10
SNAPLOCK-14	14"	5'	28 ga.	10
SNAPLOCK-16	16"	3'	26 ga.	10
SNAPLOCK-18	18"	3'	26 ga.	10
SNAPLOCK-20	20"	3'	26 ga.	10

Elbows



Elbows turn-adjust from straight to 90°

Item #	Duct Size	Case Qty.	Gauge
ELBOW-04	4"	24	30 ga.
ELBOW-05	5"	24	30 ga.
ELBOW-06	6"	24	30 ga.
ELBOW-07	7"	12	30 ga.

Item #	Duct Size	Case Qty.	Gauge
ELBOW-08	8"	12	30 ga.
ELBOW-09	9"	12	30 ga.
ELBOW-10	10"	12	28 ga.
ELBOW-12	12"	12	28 ga.

Item #	Duct Size	Case Qty.	Gauge
ELBOW-14	14"	4	28 ga.
ELBOW-16	16"	4	26 ga.
ELBOW-18	18"	4	26 ga.
ELBOW-20	20"	4	24 ga.

Backdraft Dampers

Backdraft dampers are designed with galvanized steel collars and have lightweight aluminum damper blades. They are spring-loaded for positive closure. The collar is constructed of 27ga. galvanized steel, with a galvanized aluminum blade and a foam seal.

Item #	Duct Size	Item #	Duct Size	Item #	Duct Size
CAR100	4"	CAR175	7"	CAR315	12"
CAR125	5"	CAR200	8"	CAR355	14"
CAR150	6"	CAR250	10"	CAR400	16"



Thermofin® ("T-Fin") & Non-Insulated Duct

T-Fin® air duct is a **semi-rigid** flexible aluminum pipe. This Class 0 air duct used as supply, return or exhaust. It allows extreme compression without making it harder to pull it back out for installation.

Item #	Mfg. #	Duct Size	Length	Compressed Length	Max Static	Case Qty.	End Style
TFIN-03	12903	3"	10'	23"	6" w.c.	20	Two Plain Ends
TFIN-04	12911	4"	10'	23"	6" w.c.	12	
TFIN-05	12822	5"	8'	23"	12" w.c.	7	One Crimped, One Plain
TFIN-06	12823	6"	8'	23"	12" w.c.	4	
TFIN-07	12824	7"	8'	23"	12" w.c.	3	
TFIN-08	12825	8"	8'	23"	12" w.c.	4	
TFIN-10	12827	10"	8'	23"	12" w.c.	2	
TFIN-12	12828	12"	8'	23"	8" w.c.	1	



MNI25 is a UL-181 listed and labeled Class 1 **flexible** non-insulated air connector. It is used as a supply, return, and exhaust duct in low to medium pressure AC systems and exhaust applications. Constructed with a spring steel wire helix, encapsulated in a polyester, aluminum foil, and polyester tri-laminate, with raw ends.

Item #	Duct Size	Length	Max Static	Case Qty.	Item #	Duct Size	Length	Max Static	Case Qty.
MNI25-03	3"	25'	10" w.c.	12	MNI25-08	8"	25'	10" w.c.	4
MNI25-04	4"	25'	10" w.c.	12	MNI25-09	9"	25'	10" w.c.	4
MNI25-05	5"	25'	10" w.c.	4	MNI25-10	10"	25'	10" w.c.	4
MNI25-06	6"	25'	10" w.c.	4	MNI25-12	12"	25'	10" w.c.	4
MNI25-07	7"	25'	10" w.c.	4					



Dryer Venting

Item #	Stud Size	Exterior H x W x D	Interior H x W x D	Direction	Case Qty.
DB-350	2" x 4"	21" x 12.5" x 4.4"	18.3" x 9.5" x 3.5"	Upward	6
DB-480	2" x 6" (2x4 w/ furring)	23.5" x 17.4" x 5.2"	20.5" x 14" x 4.3"	Up / Down / Sideways	5



The **Dryerbox®** fits within 16" or 24" studs. It includes a duct support tab to maintain the ideal penetration length of 2" for Snaplock conduit.

- Locate the dryer right up against the wall while protecting the flex from damage
- Doubles as gas connection receptacle
- Meets code requirements as a clean-out
- Surface is paintable, no masking needed
- Model DB-480 accommodates pedestal dryers and downward venting

The **Telescoping Dryer Duct** allows for quick and easy ducting from the dryer box to above the ceiling. It extends from 65" to 188" to meeting various height requirements.



Item #	Duct Size	Telescoping Length	Collar Size
DV-DVTA	6" x 2.5"	65" - 118"	4"

Wallstack Duct



Item #	Description	Case Qty.	Dimensions
WALLSTACK-DUCT-60	Rectangular Duct	12	60" x 3.25" x 10"
WALLSTACK-BOOT-ST	Straight Boot w/ 6" Collar	12	3.25" x 10" w/ 6" Round
WALLSTACK-BOOT-90	90° Boot w/ 6" Collar	12	
WALLSTACK-BOOT-END	Center End Boot w/ 6" Collar	12	
WALLSTACK-ENDCAP	Endcap	12	3.25" x 10"

Wallstack is low profile, rectangular metal duct. At 3-1/4" x 10", it is designed to fit in a wall between the studs, or in a ceiling between the joists. It is often used for venting kitchen range hoods.

Soffit / Eave Vents

Plastic Fixed Louver Vents

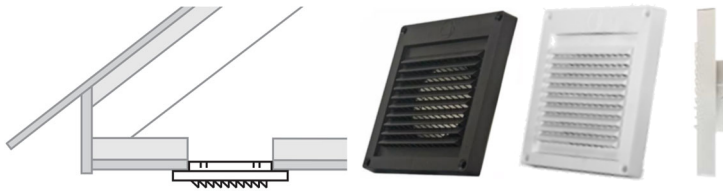

Item #	Duct Size	Louver Grid Size	Color	Mount	Case Qty.	Application
110811	4"	1/4" x 1/4"	White	Snap-On Ring	12	Fresh Air Intake or Exhaust (not dryer)
110899	6"	1/2" x 1/2"				
110972	4"	1/4" x 1/4"	Brown	Snap-On Ring	12	
111008	6"	1/2" x 1/2"				

Wall Vents

Aluminum Wall Vents



Item #	Mount	Case Qty.	Duct Size	Flapper	Screen	Gauge	Application
110557	Flush	24	4"	Yes	No	30ga.	Exhaust (Including Dryer)
110271	11.5" Neck	12					
110786	Flush	24	4"	Yes	Yes	30ga.	Exhaust (Not Dryer)
110684	11.5" Neck	12					

Plastic Wall Vents



Item #	Duct Size	Case Qty.	Louver Type	Color	Mount	Application
111149	3" - 4"	24	Free-Swinging	White	Flush	Exhaust (Including Dryer)
110840	6"	12				
111151	3" - 4"	24	Free-Swinging	Brown	Flush	
110844	6"	12				

Heavy-Duty Galvanized Wall Vents



Item #	Duct Size	Flapper	Screen	Mount	Gauge	Case Qty.	Paintable	Application
112211	4"	Yes	1/4" Grid (removable)	11" Tail	26ga.	12	Yes	Exhaust (Including Dryer)
112524	6"	Yes (removable)	1/4" Grid (removable)	11" Tail	26ga.	6	Yes	Fresh Air Intake or Exhaust
112323	8"	Yes (removable)	1/4" Grid (removable)	11" Tail	26ga.	6	Yes	
011029	10"	Yes (removable)	1/4" Grid (removable)	11" Tail	26ga.	1	No	

Furnace Concentric Vents

Hi-Efficiency Condensing Furnaces (90%+) require two-pipe venting - one for intake, and one for exhaust. PVC piping is used, since it does not corrode from the acidic condensation.

Concentric Vents make it easier to have a two pipe installation for high efficiency furnaces. These vents only require one hole through the wall or roof, instead of two.

Item #	Intake & Vent I.D.	Intake Pipe O.D.	Assembly Length	Intake Pipe Length
P4D03VK	3"	4.5"	39.75"	31.9"

Concentric Roof Flashings

Item #	Flashing Type	Base Size	Pipe I.D.	Roof Pitch	Collar Type	Case Qty.
530-11911	Thermoplastic	16" x 12"	4"	Up to 12/12	No-Caulk	12
5-11879	28ga. Galv. Steel	15" x 12"	4"	Up to 12/12	Elastomer	12

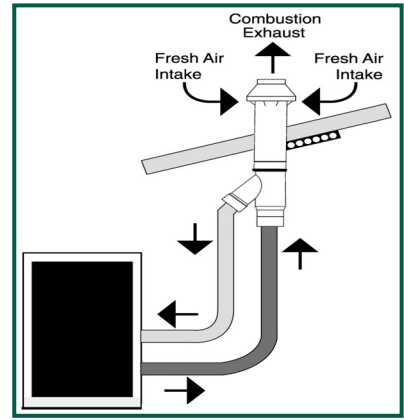
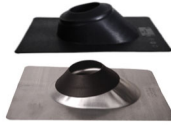

Sidewall Termination Kit

Item #	Works With
BAYVENT200B	2", 2-1/2", or 3" vent systems



Furnace B-Vent by AMERIVENT.

B-Vent Pipe is used for venting appliances that use natural gas or liquid propane. With double wall construction the inner pipe heats quickly, containing the flue gases inside. The airspace between the inner and outer pipe provides insulation, keeping the warmer flue gases on the rise. Features Snap-Lock joints that are easy to disconnect.

Round Pipe

Item #	Pipe I.D.	Length	Case Qty.
4E12	4"	12"	6
4E18	4"	18"	6
4E24	4"	24"	6
4E3	4"	36"	6
4E4	4"	48"	6
4E5	4"	60"	6

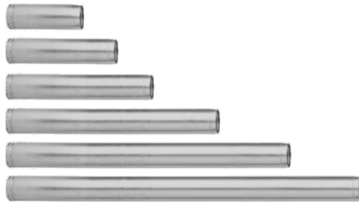

Adjustable Length Pipe slides over top of round pipe, allowing for an adjustable addition of 3" to 10"

Item #	Pipe I.D.	Length	Adjustment Range	Case Qty.
4E12A	4"	12"	3" to 10"	6

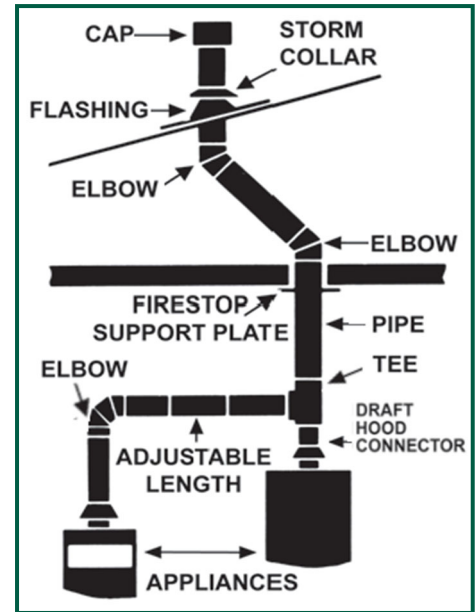

Draft Hood Connector

connects B-Vent directly to an appliance. The inlet can be shaped to fit oval outlets.

Item #	Pipe I.D.	Dimensions	Case Qty.
4EDC	4"	6.6" Overall 2.9" Flexible Inlet	6



Storm Collars & Rain Caps

Item #	Pipe I.D.	Description	Case Qty.
4ESC	4"	Storm Collar	12
4ECW	4"	Ventilation / Rain Cap	12

The Rain Cap can be used as a ventilation cap for both standard exhaust and B-Vent termination. The ports and baffles keep rain and debris out.

Elbows & Adapters

Item #	Type	Pipe I.D.	Case Qty.
4EAL	0° to 90° Elbow	4"	6
4EUA-F	Female Adapter	4"	6
4EUA-M	Male Adapter	4"	6
4EIX5	4" to 5" Adapter	6	

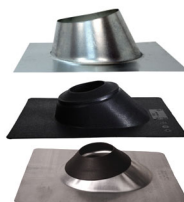

B-Vent Roof Flashings

Pipe I.D.	Type	Item #	Roof Pitch	Dimensions L x W x H	Case Qty.
4"	Metal	4EF	0/12 to 6/12	16.4" x 13.8" x 5"	12
		4EF12	6/12 to 12/12	17.9" x 15" x 6.8"	12
4"	No-Caulk Plastic	530-11911	Up to 12/12	16" x 12"	12
	No-Caulk Steel	5-11879	Up to 12/12	15" x 12"	12

Roof Vents

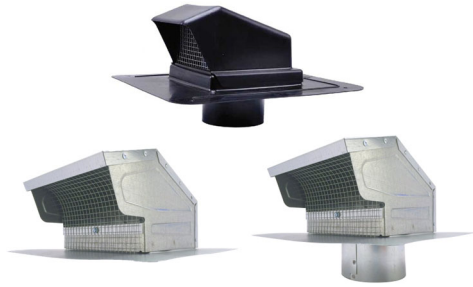

Plastic Roof Vent with Flashing

Item #	Duct Size	Case Qty.	Mount	Flapper	Screen	Material	Application
PBRV04	4"	10	Collar	Yes	Steel Mesh (removable)	Black Plastic	Exhaust (Including Dryer)
PBRV06	6"	8	Collar				
011756	4"	1	Collar	Yes	1/4" x 1/4" (removable)	26ga. Galvanized Steel	
011772	6" - 8"	1	Flush				
011774	10"	1	Flush				



Tapered Roof Jack With Vent Cap

Item #	Duct Size	Roof Pitch	Flapper	Screen	Case Qty.
ROOFJACK-04-9/12	4"	9 / 12	No	No	10
ROOFJACK-06-9/12	6"	9 / 12	No	No	8
ROOFJACK-08-9/12	8"	9 / 12	No	No	5

RoofGoose Lineset Penetration Flashings



Height	Type	End Type	Opening Size	Item #
12"	Lineset Jack	Flexible Boot	4"	RJ4-UTILITY
			6"	RJ6-UTILITY
	Exhaust / Intake	Screen & Removable Damper	4"	RJ4-IE
			6"	RJ6-IE

Designed to easily accommodate soft copper line sets, the **RoofGooseJack** is an easier and higher quality approach to lineset doghouses and pitch pockets.

RJ*-UTILITY Additional Contents:

- (1) 6" Flexible Utility Jacket
- (2) quick draw stainless steel clamps
- (2) Nested Sets of Draftstopping

RJ*-IE Additional Contents:

- (1) Removable Flapper Assembly
- (1) Bug Cap w/ Stainless Steel Screen

- All Units Contain:**
- (1) 6" Base with Flange
 - (1) 6" RoofJack Lid
 - (5) 8" Roof Fasteners
 - (1) Rubber Gasket

Many Other RoofGoose Sizes & Styles Are Available!

Fresh Air Ventilation



The **Fresh-Air Filter Rack** is a simple way to pre-filter fresh air before it reaches the return air ductwork. It has a 12" flanged opening on one side, and a ductboard back on the other to accommodate many duct sizes.

In Line Fresh-Air Filter Rack

Item #	H x W x D	Filter Size	Insulation
12X12FAFRERY	12" x 12" x 6"	12" x 12" x 2" (Nominal)	R8 with a Ductboard Back

The **Y8150A1017** Fresh Air Ventilation System provides fresh air to a home. The control operates a fresh air intake damper and, when needed, activates the main HVAC blower to efficiently meet ASHRAE ventilation rates.



Fresh Air Ventilation System

Item	Description	Replacement Actuator
EARD6TZ	6" Round Fresh Air Damper	M847D-VENT
EARD8TZ	8" Round Fresh Air Damper	
W8150A1001	Fresh Air Ventilation Control	
Y8150A1017	Fresh Air Ventilation Kit - Includes EARD6TZ damper, W8150A1001 control, and a 24v transformer	



The **FIN-180P-HW** is for fresh air, exhaust, or transfer. It has a hi-eff. ECM motor with selectable CFM. It has a backdraft damper, metal pre-filter, and a 2" rail for an additional filter. Onboard algorithms select the best time of day for ventilation, takes advantage of blower usage, and employs outdoor temperature and humidity limits.

Fresh Air Supply Fan

Item #	Voltage	H x W x L	CFM @ .2 w.g.	Optional Filter	Collar Size
FIN-180P-HW	115v Hard Wired	10" x 10.25" x 14.75"	30 - 180 Selectable	10" x 10" x 2"	6"

Energy Recovery Ventilators (ERVs)

ERVs use two fans at the same time. One fan pulls fresh air indoors, while the second fan moves stale air to the outside. When the air streams cross, a heat exchanger sends moisture and heat from one air stream to the other. The system can transfer a majority of the energy from the stale, outgoing air and apply it to the fresh, incoming air. This allows the ERV to provide fresh air at a temperature and humidity level closer to the temperature of the air already inside.

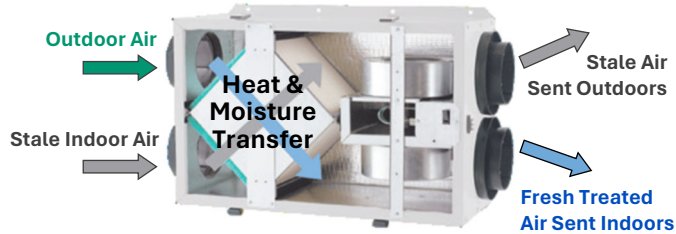

Trane® ERV Systems

Item #	CFM	Dimensions H x W x D	Replacement Filter
EERVR100A1P00B	120	20.13" x 28.75" x 13"	FLR08618
EERVR200A1P00B	200	20.13" x 28.75" x 23.88"	FLR08619
EERVR300A1P00B	300	20.13" x 28.75" x 23.88"	FLR08619



- 6" & 8" double collar duct connections for EERVR100 and 200
- 8" round compatible duct connection for EERVR300
- Closed cell foam gasketing for insulation integrity
- 1" duct board insulation with cleanable foil face
- Passive defrost - condensate drain not required
- Pressure ports are accessible through front panel without door removal
- "Guillotine" type dampers are included to balance for correct airflow
- Percent Timer (PT) control included for simple, automatic operation

Dehumidifiers

Most HVAC systems naturally remove a certain amount of moisture while adding cool air to the space for comfort. When the HVAC system can't achieve optimal RH%, dehumidifiers can help. These units can reduce the workload on the HVAC system, which can increase its lifespan and reduced repair and maintenance costs. Dehumidifiers reduce moisture levels in the air, increasing comfort and helping to prevent mold, mildew, and odors.

Typical HVAC Applications

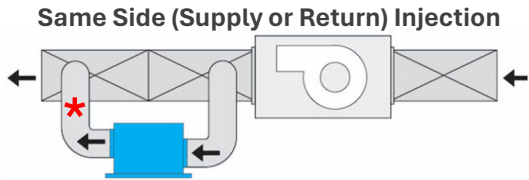
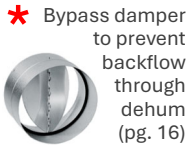
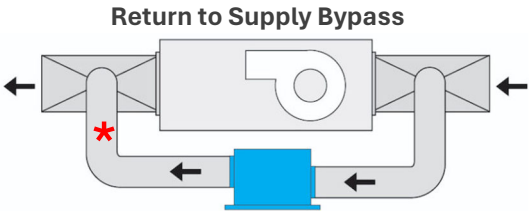
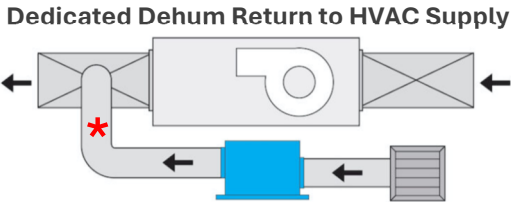
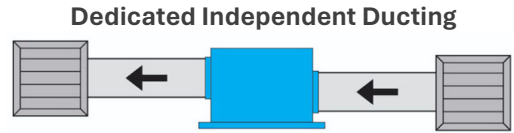

Dehumidifiers from Honeywell Home

Whole Home Dehumidifiers are integrated into the HVAC equipment, which means they're more effective and can be less expensive than putting multiple single-room units in a home. Plus, DR90 and DR120 dehumidifiers are ENERGY STAR® rated providing efficient and economical operation.

Whole Home Dehumidifiers can also be used as a standalone solution to quietly remove moisture from specific problem areas, improve comfort and eliminate the need for maintenance (such as emptying collection buckets) — all while using less energy compared to most portable dehumidifiers.



Item #	Moisture Removal @ 80°F, 60% RH	Fresh Air Connection	Standalone Controls	Voltage	Replacement Filter	Dimensions W x H x L	Recommended Drain Pan
DR65A3000	65 pints Per Day	No	Yes	120v	50049537-005	12" x 12" x 28.5"	PAN-18X44
DR90A3000	90 pints Per Day	Yes - 6"	No	120v	50070171-002	14.4" x 19.33" x 32.4"	PAN-18X44
DR120A3000	120 Pints Per Day	Yes - 6"	No	120v	50070171-002	14.4" x 21.25" x 32.4"	PAN-18X44



QUEST Commercial Dehumidification

DEHUMIDIFIERS



The **Quest 100** is perfect for small projects and spaces. The patented M-CoRR multi-coil design recycles excess heat to provide the highest energy efficiencies available on the market, while reducing heat (BTUs) output into the space.

The **Quest Dual 155 & 205** are the highest capacity 115v dehumidifiers. Using 13.2 amps @ 115v, the Dual 205 removes 205 pints per day while running 46% more efficiently than Energy Star standards.



The **Quest 225 & 335** boast energy-efficient patented M-CoRR coil technology. These units feature a compact size, digital controls with a terminal block for optional external controls, and integrated lift and hang points.

The **Quest 506 / 746 / 876** are powerhouse machines designed to work round-the-clock with maximum energy efficiency and flexibility. Featuring integrated handles and hang points, they can be suspended overhead, freeing up valuable floor space.



Model	Item #	Voltage	Amp Draw	Moisture Removal @ 80°F, 60% RH	Standalone Controls	Dimensions L x W x H	Replacement Filter	Recommended Drain Pan
100	4041870	115v	5.0	100 Pints Per Day	Yes - Electronic	24" x 16" x 14.5"	12" x 14" x 1"	PAN-18X44
Dual 155	4031490	115v	8.0	155 Pints Per Day	Yes - Dial	37.9" x 20.3" x 21.8"	16" x 20" x 2"	PAN-32X40
Dual 205	4033060	115v	13.2	205 Pints Per Day	Yes - Dial	37.9" x 20.3" x 21.8"	16" x 20" x 2"	PAN-32X40
225	4042800	230v / 1-Phase	5.3	225 Pints Per Day	Yes - Electronic	26.8" x 23.6" x 20.9"	18" x 18" x 2"	PAN-32X36
335	4042500	230v / 1-Phase	9.0	350 Pints Per Day	Yes - Electronic	32.9" x 23.7" x 24.6"	20" x 22" x 2"	PAN-32X40
506	4036600	230v / 1-Phase	11.0	506 Pints Per Day	No	44.8" x 28.9" x 34.1"	18" x 20" x 2"	PAN-32X60
746	4037610	480v / 3-Phase	6.5	746 Pints Per Day	No	44.8" x 28.9" x 34.1"	18" x 20" x 2"	PAN-32X60
876	4037600	230v / 1-Phase	22.4	876 Pints Per Day	No	44.8" x 28.9" x 34.1"	18" x 20" x 2"	PAN-32X60

Duct Transitions for Quest Dehumidifiers

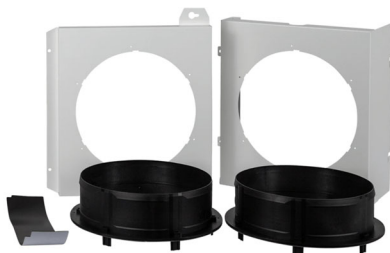

Model	Return Kit	Supply Kit	Duct Size
100	4042265 (Combo Kit)		10" Round Return & Supply
Dual 155	4028610	4028607	12" Round Return / (2) 10" Round Supply
Dual 205	4028610	4028607	12" Round Return / (2) 10" Round Supply
225	4043235 (Combo Kit)		14" Round Return & Supply
335	4042685 (Combo Kit)		16" Round Return & Supply
506	4038642	4038641	21.3" x 36.4" Return / (2) 12" Round Supply
746	4038642	4039868	21.3" x 36.4" Return / 22.9" x 29.4" Supply
876	4038642	4039868	21.3" x 36.4" Return / 22.9" x 29.4" Supply

Dehumidifier Controls

Integrate a dehumidifier into the central HVAC system using a thermostat with dehumidification terminals. Or use the HumidiPro for dedicated control.

YTHX9421R5085WW Prestige IAQ	TH8321R1001 VisionPRO 8000	THX321WFS3001W T10 Pro Smart Series	H6062A1000 HumidiPRO Control
<ul style="list-style-type: none"> High-def, full-color display RedLINK® technology & accessories Sliding scale shows actual and desired humidity levels 	<ul style="list-style-type: none"> All-in-one control for the space RedLINK® technology and accessories Smart Schedule programs in seconds 	<ul style="list-style-type: none"> Control from thermostat or app Energy savings through scheduling and geo-fencing Add RedLINK® Room Sensors to extend reach of thermostat 	<ul style="list-style-type: none"> Wired outdoor sensor included Automatically adjusts indoor setting based on outdoor conditions

Exhaust / Intake Grilles

Item #	CFM	Collar Size	Grille Diameter
BOR-100	15 - 100	3-1/8"	5-1/2"
BOR-150	45 - 235	5-1/8"	8"

White plastic air grille for residential and commercial applications. All models have an adjustable central valve to regulate the airflow. Suitable for both supply and exhaust applications.



Inline Mixed-Flow Fans

Model	Duct Size	Nom. RPM	Volts	Max. CFM	Max. Static Pressure	Max. Temp.	Height & Width	Length	Speed Control	Casing
TD-100	4"	2516	120v	101	0.4"	104°F	5-15/16"	9-1/8"	2727.1	ABS Plastic
TD-125	5"	2146	120v	197	0.55"	104°F	7-3/8"	10-3/16"	2727.1	
TD-150	6"	2289	120v	293	1.15"	140°F	8-3/8"	11-5/8"	2727.1	Steel w/ Epoxy Coating
TD-200	8"	2781	120v	538	1.625"	104 F	9-3/16"	11-7/8"	2727.1	
TD-250	10"	3200	115v	754	2.53"	140°F	11-7/16"	15-3/16"	2727.1	
TD-315	12.4"	2500	115v	1050	2.95"	140°F	14"	17-11/16"	2727.1	
TD-355	14"	1536	115v	2089	1.0"	140°F	17-3/4"	17-11/16"	2727.1	
TD-400	16"	1559	115v	3127	1.2"	140°F	19-3/8"	21-1/2"	2828.1	

TD Fans have a powerful motor with a mixed flow impeller. This enables the fans to deliver high airflow with minimum noise generation against high static pressures. The unique support brackets allow the unit to be fitted or removed without dismantling the adjacent ducting, making install and service easy.



New Construction Bathroom Fans by **BROAN**

Economy Series

Housing Rough Kit

Item #	Duct Size	Case Qty.	Dimension H x W x D
1667EH	3"	6	3.7" x 7.5" x 7.25"
6884EH	4"	18	

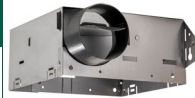

Motor - Blade - Grille Finish Kit

Item #	CFM	Sones	Voltage	Grille Size	Energy Star	Case Qty.
1688EF	50	2.0	120v	9" x 8.75"	Yes	6



Flex Series

Flex Series® fans have foldable mounting ears, a new damper, and tighter housing to decrease air leakage. It has quiet performance, with enough sound to know the fan is on. TrueSeal™ Dampers reduce air leakage, and the EzDuct™ connector can be installed from the room side, with no attic access required.

Housing Rough Kit

Item #	Dimension H x W x D	Duct Size	Case Qty.
A000HFNF	5.75" x 9.25" x 10"	4"	4

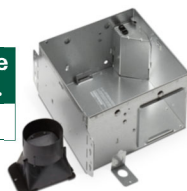

Motor - Blade - Grille Finish Kit

Item #	CFM	Sones	Voltage	Grille Size	Energy Star	Case Qty.
AE80BF1	80	1.2	120v	11.25" x 12"	Yes	4



New Construction Project Packs provide the housing for the fan separately from the grille and motor. This allows the contractor to install the housing "can," without worrying about damaging the fan and grille. Once all construction is complete, the motor/blade/grille kit is installed to finish the trim-out.



Bathroom Fans - Retrofit

Flex DC™ Series Fan with Selectable CFM



Item #	Features	CFM	Sones	Voltage	Grille Size	Housing Size H x W x D	Duct Size	Energy Star
AE50110DC	Fan Only	50 - 80 - 110	0.3 - 0.4 - 0.9	120v	11.5" x 12"	5.75" x 9.25" x 10"	4"	Yes
AE50110DCL	Fan & Light							

Flex DC™ Fans allow for field selection between 50, 80 or 110 CFM. Retrofit installations can be done entirely from the room-side – no attic access required. They have a plug in, permanently lubricated, brushless DC motor – engineered for continuous operation. They can be installed in a wall if mounted 8 ft. or more above the floor.

Lo-Profile DC Series Fan with Selectable CFM



Item #	Features	CFM	Sones	Voltage	Grille Size	Housing Size H x W x D	Duct Size	Energy Star
LP510RS	Fan Only	50 - 80 - 100	0.3 - 0.4 - 1.2	120v	13" x 13.75"	3.4" x 10.75" x 10.75"	4" Oval	Yes
LP510RSL	Fan & Light							

Lo-Profile DC Fans are narrow enough to be installed in a wall between 2x4 studs. The built-in humidity sensor turns the fan to high speed when increases in humidity are detected. This fan features TRUE CFM™ - the fan will not lose CFM performance regardless of how complicated the ducting. This bath fan meets ASHRAE 62.2 & ENERGY STAR®.

Fan - Light - Heater Combo



Item #	Features	CFM	Sones	Voltage	Grille Size	Housing Size H x W x D	Duct Size	Energy Star
BHFLED80	Fan - LED Light - Heater	80	1.5	120v	9.75" x 16.25"	5.75" x 8.25" x 14.25"	4"	No
P3RW	3-Function Rocker Switch Wall Control. Three independent, 120v 15a rocker switches.							

Broan® PowerHeat™ has a 1300-watt heater for instant heat when you want it. It features an integrated dimmable LED with color adjustable CCT lighting; Choose between warm white (2700K), bright white (3500K), and daylight (5000K) color options. LED Dimmable Lighting may be used as a nightlight with a separate dimmer switch.

Hi-Capacity / Commercial Fans



Model	Type	CFM	Sones	Grille Size	Housing Size H x W x D	Duct Size	Energy Star
L100E	Ceiling	130	.3	14" x 14"	11.75" x 12.25" x 12.25"	8"	Yes
L150E	Ceiling	200	1.0	14" x 14"	11.75" x 12.25" x 12.25"	8"	Yes
L200E	Ceiling	230	1.3	14" x 14"	11.75" x 12.25" x 12.25"	8"	Yes
L250E	Ceiling	270	1.5	14" x 14"	11.75" x 12.25" x 12.25"	8"	Yes
L300E	Ceiling	310	2.5	14" x 14"	11.75" x 12.25" x 12.25"	8"	Yes
MG1	Optional Metal Grille						
RD1	1 - 3 Hour Radiation Damper with 212°F fusible Link. 3.62" H x 12.5" W x 12.5" D						



Model	Type	CFM	Sones	Grille Size	Housing Size H x W x D	Duct Size	Energy Star
L400	Ceiling	434	2.3	14" x 23.25"	11.75" x 12.25" x 21.5"	4.5" x 18"	No
L500	Ceiling	514	3.3	14" x 23.25"	11.75" x 12.25" x 21.5"	4.5" x 18"	No
L700	Ceiling	701	4.7	14" x 23.25"	11.75" x 12.25" x 21.5"	4.5" x 18"	No
RD2	1 - 3 Hour Radiation Damper with 212°F fusible Link. 3.62" H x 12.5" W x 21.75" D						

Commercial Rooftop Exhaust Fans

The **SDBD Centrifugal Downblast Roof Exhaust Fans** are generally used to exhaust air from all types of commercial and institutional buildings such as hospitals and health care facilities, schools, recreational buildings, machinery and equipment rooms, offices, retail stores and similar applications.

Model SDBD direct drive fans are designed to exhaust air up to 4,980 CFM in high static pressure applications to 2-1/4" w.g. The spun aluminum exterior provides an attractive appearance. The backward inclined wheel with its higher static pressure capability makes this unit suitable for either ducted or non-ducted applications. Its roof mounting permits location near the area to be ventilated, allowing short duct runs and more efficient operation.

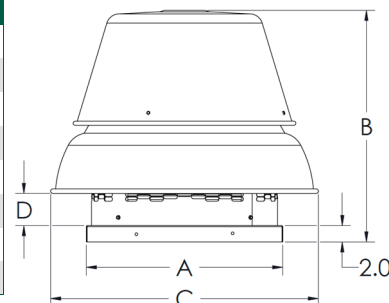

Direct Drive Exhaust Fans - Downblast - 115v/1/60

Item Number	Size	Motor			Max CFM @ 0 w.g.	Dimensions				Roof Opening	Curb O.D.	Damper O.D.
		H.P.	RPM			A	B	C	D			
SDBD06JH1AS	6	1/10	1550	351	18"	14.13"	22.32"	1.5"	13.5"	16.5"	12"	
SDBD07JH1AS	7	1/10	1550	476	18"	16.82"	22.32"	4.13"	13.5"	16.5"	12"	
SDBD08JH1AS	8	1/10	1550	862	18"	20.5"	22.32"	4.13"	13.5"	16.5"	12"	
SDBD10PH1AS	10	1/3	1625	1348	18"	20.5"	22.32"	5.13"	13.5"	16.5"	12"	
SDBD12QH1AS	12	1/2	1625	1885	20"	27.32"	27.63"	3.88"	15.5"	18.5"	14"	
SDBD14MM1AS	14	1/4	1075	2216	20"	27.32"	27.63"	3.88"	15.5"	18.5"	14"	
SDBD15QM1AS	15	1/2	1150	2683	24"	28"	32.88"	4"	19.5"	22.5"	18"	
SDBD16QM1AS	16	1/2	1150	3330	24"	28"	32.88"	4"	19.5"	22.5"	18"	

Direct Drive Exhaust Fans - Upblast - 115v/1/60

Item Number	Size	Motor			Max CFM @ 0 w.g.	Dimensions				Roof Opening	Curb O.D.	Damper O.D.
		H.P.	RPM			A	B	C	D			
STXD10RHULPH1AS	10	1/3	1625	1445	18"	25.32"	28.63"	23.32"	13.5"	16.5"	12"	
STXD12RHULQH1AS	12	1/2	1625	1918	20"	26.94"	31.32"	24.94"	15.5"	18.5"	14"	
STXD14RHULMM1AS	14	1/4	1075	2148	20"	26.94"	31.32"	24.94"	15.5"	18.5"	14"	
STXD15RHULQM1AS	15	1/2	1140	2643	24"	27.63"	36.5"	25.63"	19.5"	22.5"	18"	
STXD16RHULQM1AS	16	1/2	1140	3187	24"	27.63"	36.5"	25.63"	19.5"	22.5"	18"	

The **STXD-RHUL Centrifugal Upblast Roof Exhaust Fans** are also direct drive fans. They are UL762 listed as power ventilators for restaurant exhaust appliances, and are designed to eject contaminated or grease-laden air. Typical applications include restaurant hoods and similar kitchen exhaust ventilation, fume and smoke removal, laboratory fume hood exhaust and chemical process exhaust.

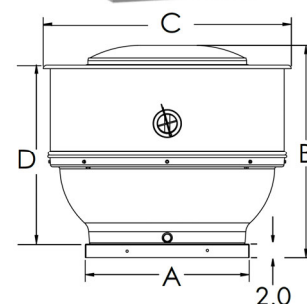

Commercial Rooftop Fan Accessories

Roof Mounting Curbs

Item #	O.D. Square	Height	Fits Fan Size
711216	16.5"	12"	6, 7, 8, 10
711218	18.5"	12"	12, 14
711222	22.5"	12"	15, 16

Gravity Backdraft Dampers

Item #	O.D. Square	Height	Fits Fan Size
411012	12"	2"	6, 7, 8, 10
411014	14"	2"	12, 14
411018	18"	2"	15, 16

Speed Controller

Item #	Voltage	For Fan Size
2727.1	115v	6 - 14
2828.1	115v	15, 16





The **InnovairFlex D4120** is a 4-wire photoelectric duct smoke detector that features a pivoting housing that fits both square and rectangular footprints, and mounts to round or rectangular ductwork. As many as 50 InnovairFlex detectors can be interconnected. When one unit senses smoke, all interconnected detectors will switch their relays; only the detector sensing smoke will go into alarm, thus pinpointing the fire source.

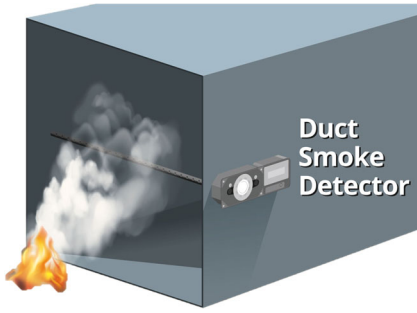

Item #	Duct Smoke Detector
D4120	4-Wire Photoelectric Low-Flow Duct Smoke Detector
D4120W	NEMA 4 - Watertight Version of the D4120



Item #	Sampling Tubes
DST1	Metal Sampling Tube: Duct Widths up to 1'
DST1.5	Metal Sampling Tube: Duct Widths of 1' - 2'
DST3	Metal Sampling Tube: Duct Widths of 2' - 4'
DST5	Metal Sampling Tube: Duct Widths of 4' - 8'
DST10	Metal Sampling Tube: Duct Widths of 8' - 12'



RTS151



RTS151KEY



MHR



MHW



APA151



RTS2-AOS

Item #	Accessories
RTS151	Remote Test Station
RTS151KEY	Remote Test Station w/ Key Lock
MHR	Mini-Horn Alarm (Red Wall Plate)
MHW	Mini-Horn Alarm (White Wall Plate)
APA151	Remote Annunciator w/ Piezo Alarm
RTS2-AOS	Multi-Signaling Unit w/ Add-On Strobe Light

The **MHR & MHW** mini-horns have two tone and two volume settings.

The **APA151** annunciator provides an audible alarm, a red LED for alarm status, and green for power status. For applications without a control panel, to comply with NFPA 90A.

The **RTS151 & RTS151KEY** remote test stations are designed to test duct smoke detectors from a convenient location.

The **RTS2-AOS** multi-signaling unit includes a key switch that can be used to select one of two connected sensors to be tested and reset.

Smoke Testing



Smoke Candles produce a dense white smoke ideal for testing exhaust fans, checking for leaks in ductwork, and determining air flow patterns.



QwikSmoke® is a universal smoke alarm test gas. Designed for use with all smoke detectors; with and without functional test mode capability; battery operated or hard wired. Fast, reliable and easy to use - takes less than 30 seconds for most detectors.

Item #	Description	Size
ZS301A	#1A Smoke Candle - 4,000 Cubic Feet of Smoke in 30 Sec.	1.5" x 1.5"
QT2330	QwikSmoke™ Smoke Alarm Test Gas	2.9 oz.

Air Pressure Sensing Switch



The **Adjustable Style RSS Series** has adjustable set points, and is factory-set to activate on pressure rise. In furnace applications, it proves fan flow by sensing draft down from blower; switch actuation allows the ignition start up, or shuts the system down upon insufficient draft. Electronic air cleaners can employ sensing switches to prove airflow; switch actuation starts unit with sufficient airflow or draft.

Item #	Range in Inches of W.C.	Contact Type
RSS495011	0.25" to 1.0" w.c.	SPDT

24" x 24" T-Bar Lay-In Grilles - Steel

Supply Diffusers - With Insulated Back

3-Cone, 4-Way		Flat Panel		Perforated	
Part #	Case Qty.	Part #	Qty.	Part #	Qty.
GRD-HVS-R6	2	GRD-DPD-R6	2	GRD-RENPS-R6	4



Filtered Returns - With Insulated Back

Stamped with Filter		Louvered with Filter		Perforated with Filter	
Part #	Case Qty.	Part #	Qty.	Part #	Qty.
GRD-659TI-R6	2	GRD-96AFBTI	2	GRD-PFTI-R6	2

20" x 20" x 1" Nominal Filters

Return Grilles - With Insulated Back

Perforated		Eggcrate	
Part #	Case Qty.	Part #	Qty.
GRD-RENPS-R6	4	GRD-RE5TI	4

24" x 24" T-Bar Lay-In Grilles - Plastic

Modular Core Supply		Eggcrate Filter Return		Back Panel: 6" - 16"	
Part #	Case Qty.	Part #	Case Qty.	Part #	Case Qty.
GRD-RZ-2154	5	GRD-RZ-2164	5	GRD-RZ-2155	5

The **Modular Core Diffuser** has four adjustable cores, allowing for one, two, three, or four-way air patterns.

The **Eggcrate Filtered Return** can be used with or without a 20" x 20" x 1" nominal filter.

The **Adjustable Back Panel** has pre-built 6" hole, with scored rings up to 16" to accommodate multiple collar sizes. It has a friction fit to the back of the diffuser.

Plastic Supply Grilles

Rezzin™ polymer plastic grilles are perfect for applications with high moisture, or where constant cleaning is required.

- Multi-shutter damper
- Bright White finish

	Size	Item #	Case Qty.
4-Way 	6" x 6"	GRD-RZ4-0606	20
	8" x 8"	GRD-RZ4-0808	20
	10" x 10"	GRD-RZ4-1010	20
	12" x 12"	GRD-RZ4-1212	10

	Size	Item #	Case Qty.
3-Way 	8" x 4"	GRD-RZ3-0804	20
	10" x 6"	GRD-RZ3-1006	20
	10" x 8"	GRD-RZ3-1008	20
	12" x 6"	GRD-RZ3-1206	20
	14" x 6"	GRD-RZ3-1406	20
	14" x 8"	GRD-RZ3-1408	20

Vertical Sidewall Supply Grilles

Size	Item #	Case Qty.
8" x 4"	GRD-821-0804	10
10" x 6"	GRD-821-1006	10
10" x 8"	GRD-821-1008	10
10" x 10"	GRD-821-1010	5
12" x 6"	GRD-821-1206	10
12" x 8"	GRD-821-1208	10

Size	Item #	Case Qty.
12" x 12"	GRD-821-1212	5
14" x 6"	GRD-821-1406	10
14" x 8"	GRD-821-1408	10
16" x 6"	GRD-821-1606	10
20" x 6"	GRD-821-2006	5



The **821 Series** is a steel, vertical, straight-blade supply register with multi-louver damper volume control for sidewall installation.

- All-steel construction w/ metal handle
- Vertical, adjustable face bars
- Horizontal multi-shutter valve
- Bright White finish

Direction	Size	Item #	Case Qty.
3-Way 	8" x 4"	GRD-683M-0804	20
	10" x 6"	GRD-683M-1006	20
	10" x 8"	GRD-683M-1008	20
	12" x 6"	GRD-683M-1206	20
	12" x 8"	GRD-683M-1208	20
	14" x 6"	GRD-683M-1406	20
	14" x 8"	GRD-683M-1408	10

Ceiling Supply Grilles

Direction	Size	Item #	Case Qty.
4-Way 	6" x 6"	GRD-684M-0606	20
	8" x 8"	GRD-684M-0808	20
	10" x 10"	GRD-684M-1010	20
	12" x 12"	GRD-684M-1212	10

The **680M Series** is a stamped, straight blade supply register with multi-louver damper for ceiling or sidewall installation.

- All-steel construction with metal handle
- One-piece face w/ damper for control
- Fins spaced on 1/2" centers at 40°

Filter Frame Return Grilles

Size	Item #	Case Qty.
12" x 12"	GRD-673-1212	5
12" x 24"	GRD-673-1224	5
24" x 12"	GRD-673-2412	5
12" x 36"	GRD-673-1236	1
14" x 14"	GRD-673-1414	5
14" x 20"	GRD-673-1420	5
14" x 25"	GRD-673-1425	5
25" x 14"	GRD-673-2514	5
16" x 16"	GRD-673-1616	5
16" x 20"	GRD-673-1620	3
16" x 25"	GRD-673-1625	3
25" x 16"	GRD-673-2516	3
18" x 18"	GRD-673-1818	5
18" x 24"	GRD-673-1824	5
18" x 36"	GRD-673-1836	1
20" x 20"	GRD-673-2020	3
20" x 25"	GRD-673-2025	3
25" x 20"	GRD-673-2520	3
20" x 30"	GRD-673-2030	3
30" x 20"	GRD-673-3020	3
24" x 24"	GRD-673-2424	3
24" x 30"	GRD-673-2430	3
25" x 25"	GRD-673-2525	3

The **673 Series** steel return air filter grille:

- 1/2" spaced fins set at 40°
- Uses standard 1" thick filters
- Removable face for install & cleaning
- Adjustable filter retainers
- Bright white finish

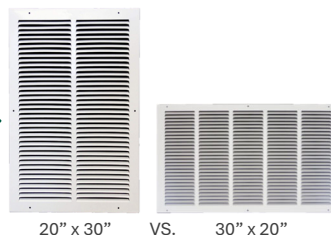

20" x 30" VS. 30" x 20"

Return Grilles

Non-Filtered Return Grilles

Size	Item #	Case Qty.
10" x 8"	GRD-672-1008	10
12" x 12"	GRD-672-1212	10
12" x 24"	GRD-672-1224	10
16" x 25"	GRD-672-1625	5
20" x 20"	GRD-672-2020	5
20" x 25"	GRD-672-2025	5
20" x 30"	GRD-672-2030	5



















The **672 Series** steel return air grille has:

- All-steel construction
- 1/2" spaced fins set at 40°
- Exceptional free area
- 5/16" Margin Turnback
- Bright White finish

PVC Pipe & Fittings

Schedule 40 PVC Fittings

Tee SLIP x SLIP x SLIP			Elbow SLIP x SLIP		Elbow SLIP x FIPT		Street Elbow SPIG x SLIP		Street Elbow MIPT x SLIP		45° Elbow SLIP x SLIP		Coupling SLIP x SLIP		Female Adapter SLIP x FIPT	
																
Size	Part #	Qty.	Part #	Qty.	Part #	Qty.	Part #	Qty.	Part #	Qty.	Part #	Qty.	Part #	Qty.	Part #	Qty.
3/4"	PVC-401-007	50	PVC-406-007	50	PVC-407-007	50	PVC-409-007	50	PVC-410-007	50	PVC-417-007	50	PVC-429-007	50	PVC-435-007	50
1"	PVC-401-010	50	PVC-406-010	50	-	-	PVC-409-010	50	PVC-410-010	50	PVC-417-010	50	PVC-429-010	50	PVC-435-010	50

Male Adapter MIPT x SLIP			Cap - SLIP		CAP - FIPT		Plug - MIPT		Threaded Union SLIP x SLIP		Running Trap		P-Trap		1/2" Teflon Tape	
																
Size	Part #	Qty.	Part #	Qty.	Part #	Qty.	Part #	Qty.	Part #	Qty.	Part #	Qty.	Part #	Qty.	Part #	Qty.
3/4"	PVC-436-007	50	PVC-447-007	100	PVC-448-007	50	PVC-450-007	50	PVC-457-007	10	PVC-488-007	100	PVC-489-007	100	6-733	
1"	PVC-436-010	50	PVC-447-010	50	-	-	-	-	PVC-457-010	10	-	-	PVC-489-010	50		



PVC Pipe

PVC Pipe - 10' Lengths



Size	Part #	Qty.
3/4"	PVC-PIPE-007	10
1"	PVC-PIPE-010	10

Reducers: 1" to 3/4"

Reducing Adapter 1" MIPT x 3/4" SLIP		Reducing Bushing 1" SPIG x 3/4" SLIP	
			
Part #	Qty.	Part #	Qty.
PVC-436-131	50	PVC-437-131	50

PVC Glossary

Type	Description
SLIP	A female fitting that slides over the pipe size
SPIG	Spigot - a "street" fitting that is the exact pipe size (fits inside a SLIP)
MIPT	Male Iron Pipe Thread
FIPT	Female Iron Pipe Thread

Ball Valves

Item #	Description
P4FBV-3/4	3/4" SLIP x SLIP Ball Valve
JV1	3/4" SLIP x SLIP Jones Valve with 1/4" Male Flare Blowout Connection



The JV1 Jones Valve is a simple condensate drain line blow out valve. Easily clear clogged drain lines by closing the valve, and blowing nitrogen through the 1/4" male flare with Schrader valve.

PVC Glues & Primers by



Item #	Size	Case Qty.	Name	Features / Application
55902	8 oz.	24	"Gene" Regular Body PVC Glue	Fast Drying - Clear Color Up to 2" Pressure Schedule 40
55988	4 oz.	24	"Hot" Quick Set Medium Body PVC Glue	Fastest Drying - Blue Color Up to 6" Schedule 40 Up to 1-1/4" Schedule 80
55989	8 oz.	24		
55990	16 oz.	12		
55952	16 oz.	12	"Gold" Heavy Body PVC Glue	Clear Color - Industrial Strength Up to 12" Schedule 40/80
55912	8 oz.	24	"Jim" Purple Primer	Hi-Etch Primer Prepares Surface for Superior Bonding Strength



Overflow Switches

SAFE-T-SWITCH™



In-Line: SS1



Auxiliary Port on Primary Drain: SS2



Secondary Pan Mount: SS3



Commercial Package Units: SS500EP



Ductless Units: SS610E



Item #	Mfg. #	Type / Features	Case Qty.
97085	SS1	In-Line Float Switch (Magnetic Reed) Includes Cleanout Tool	24
97087	SS2	Installs on the Auxiliary Outlet of the Primary Drain Pan with 3/4" Adapter	24
97089	SS3	Thumbscrew Bracket Mount Float Switch for Secondary Drain Pans	24
97693	SS500EP	Plenum-Rated Primary Pan Sensor for Commercial Package Units	24
97622	SS610E	Ductless Condensate Switch Clips to Pan or Coil	12



AG-1100+



AG-3150E



AG-3180E

RATED BODY & CABLE
Plenum



Item #	Mfg. #	Type / Features	Case Qty.
96100	AG-1100+	Magnetic Float Switch System for Metal Secondary Drain Pans	30
96124	AG-3150E	For Auxiliary Port on Primary Pan w/ Bonus Secondary Sensor	10
96128	AG-3180E	Plenum-Rated Micro Pan Sensor for Commercial Package Units	10



CS-1



BG-301



BG-101



Item #	Type / Features	Case Qty.
CS-1	In-Line Float Switch (Magnetic Reed)	10
BG-301+	Latching Float Switch w/ Clear Status Window & Manual Reset for Auxiliary Port on Primary Pans	30
BG-101	Latching Float Switch w/ Manual Reset for Secondary Pans	20



The **Combat P-Trap** is an all-in-one solution: p-trap, isolation ball valve, cleanout tool, and chemical dispenser in one device.

- To clear blockage, simply remove cap and basket. Use preferred type of device (Vacuum, CO2 gun, nitrogen).
- Close ball valve for cleaning. No need for cutting drain line.
- Fits all chlorine tabs on the market
- Easily insulated with standard insulation

“Combat” P-Trap

Item #	Description	Case Qty.
CPT-100	Combat P-Trap	10

Condensate Pumps

Item #	Voltage	Style	H x W x D	Lift	Flow @ 1' Head	Tank Size	Tubing Included?
BK221TUL	120v	Traditional	6.6" x 11.2" x 5.2"	22'	125 GPH	2.5 Quarts	20ft. of 3/8" Tubing
BK222TUL	230v						
CL201UL	120v	Low Profile	4.9" x 10.6" x 5"	20'	145 GPH	.85 Quarts	No
CL202UL	230v						
IPC13AT	120v	Submersible	4" x 8" x 3.1"	12'	81 GPH	Optional Tank 3.5" x 10.1" x 3.5"	20ft. of 3/8" Tubing



Replacement Check Valves

Item #	Description	Item #	Description
CP-CV	3/8" Barb x 3/4" Threaded Check Valve 	CRP1722	Twist-lock Check Valve for Beckett 



Ductless Condensate Pumps

Brand	Item #	Name	Voltage	Type	L x W x H	BTU Range	Max Head	Capacity	Sound
BLUEDIAMOND	X86-003	MICROBLUE®	110 - 230v	Concealed	5.8" x 1.5" x 1.6"	Up to 18,000	16 ft.	1.3 gal./hour	17 dB(A)
	X86-011	MICROBLUE®	110 - 230v	Undermount	11.3" x 3" x 2.7"	Up to 18,000	16 ft.	1.3 gal./hour	17 dB(A)
	X87-721	MAXIBLUE®	208 - 230v	Remote Mount	6.2" x 2.3" x 2.6"	18,000 - 48,000	23 ft.	3.7 gal./hour	21 dB(A)
	83809	Mini Aqua	110 - 250v	Concealed	6.5" x 1.2" x 1.2"	Up to 49,500	33 ft.	1.6 gal./hour	21 dB(A)
	83909	Mini Orange	110 - 250v	Remote Mount	4.3" x 1.5" x 2"	Up to 54,600	33 ft.	1.6 gal./hour	21 dB(A)
	83930	Mini White Silent+	110 - 250v	Undermount	11.5" x 1.9" x 1.3"	Up to 54,000	33 ft.	6 gal./hour	19 dB(A)



Ductless Filters & Traps

Item #	Description
83893	5/8" Pre-filter for Ductless Pumps - Protects Pump from Condensate Debris
83180	EZT-180 5/8" Waterless In-Line Trap - Permits Flow While Blocking Odors & Insects



Condensate Accessories

Hose Clamps

Item #	Size	Qty.
HC6202	1/4" to 5/8"	6pk.
HC6203	5/16" to 7/8"	6pk.
HC5410	9/16" to 1-1/8"	6pk.
HC5420	13/16" to 1-3/4"	6pk.



Vinyl Tubing

Item #	Size
7-14	1/4" x 100'
7-38	3/8" x 100'
7-58	5/8" x 100'



Nylon Barb Fittings

Item #	Size	Qty.
701-043	3/8" Barb x 3/4" MIPT (Tubing to PVC)	2pk.
701-030	1/4" x 1/4"	2pk.
701-032	3/8" x 3/8"	2pk.
701-033	5/8" x 5/8"	2pk.
701-038	3/8" Tee	2pk.
701-039	5/8" Tee	2pk.
701-046	3/8" Elbow	2pk.
701-040	5/8" Elbow	2pk.



Flexible Adapters

Item #	Size
83977	5/8" Hose to 3/4" PVC
C01-231	Flexible Step Adapter (8,13,19,25,32,38 mm)

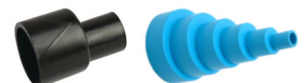



Ductless “RoughinBox”

The **RoughinBox** is for studs at 16” centers. It protects the lineset from damage and shields the drain outlet from dirt and debris. It has top and bottom lineset ports, and has vertical or horizontal condensate discharge for highwall or height restricted applications.

Item #	Description	W x H x D
RBX-3-MD-NC	Between-The-Studs Ductless Piping Box	14” x 10” x 3.5”

Black Iron Pipe & Fittings

1/2” Black Iron Fittings

Union		Coupling FIP x FIP		45° Elbow: FIP x FIP		90° Elbow: FIP x FIP		90° Street Elbow: MIP x FIP		Tee FIP x FIP x FIP		Cap		Plug	
Part #	Qty.	Part #	Qty.	Part #	Qty.	Part #	Qty.	Part #	Qty.	Part #	Qty.	Part #	Qty.	Part #	Qty.
BP-UNION	50	BP-COUPLING	60	BP-ELBOW-45	50	BP-ELBOW-90	50	BP-ELBOW-90MF	60	BP-TEE	40	BP-CAP	75	BP-PLUG	50

3/4” to 1/2” Reducers

Reducer Coupling 3/4” FIP x 1/2” FIP		Reducer Bushing 3/4” IP x 1/2” FIP	
Part #	Qty.	Part #	Qty.
BP-REDUCER	60	BP-REDUCER-MF	75

Pipe Glossary

MIPT	Male Iron Pipe Thread
FIPT	Female Iron Pipe Thread

1/2” Nipples

Item #	Size	Case Qty.
BP-NIPPLE-00	1/2” Close Nipple	25
BP-NIPPLE-02	1/2” x 2”	25
BP-NIPPLE-03	1/2” x 3”	25
BP-NIPPLE-04	1/2” x 4”	25
BP-NIPPLE-05	1/2” x 5”	25
BP-NIPPLE-06	1/2” x 6”	25
BP-NIPPLE-08	1/2” x 8”	25
BP-NIPPLE-10	1/2” x 10”	25
BP-NIPPLE-12	1/2” x 12”	25

1/2” Pipe

Item #	Size	Case Qty.
BP-PIPE-18	1/2” x 18”	5
BP-PIPE-24	1/2” x 24”	5
BP-PIPE-36	1/2” x 36”	5
BP-PIPE-48	1/2” x 48”	5
BP-PIPE-60	1/2” x 60”	5

Flexible Gas Line & Valves



Item #	Description	Case Qty.
SGV441	1/2” FIP x 1/2” FIP Brass Shutoff Valve	10
YELLOW GAS LINE 36IN	1/2” MIP x 1/2” MIP x 36”	25
YELLOW GAS LINE 48IN	1/2” MIP x 1/2” MIP x 48”	12

Pipe Sealants



Brand	Item #	Description	Case Qty.
RECTORSEAL	25551	Soft-set, slow drying pipe dope - seals, lubricates, and protects threaded pipe and fittings. Can be pressurized immediately.	24
Datey	31403D	Yellow Gas Line PTFE Thread Seal Tape	20

Copper Tubing

Soft Copper Rolls

O.D	50' Roll Item #	100' Roll Item #
1/4"	COP-025-50FT	-
5/16"	COP-031-50FT	-
3/8"	COP-037-50FT	COP-037-100FT
1/2"	COP-050-50FT	COP-050-100FT
5/8"	COP-062-50FT	COP-062-100FT
3/4"	COP-075-50FT	COP-075-100FT
7/8"	COP-087-50FT	COP-087-100FT
1-1/8"	COP-112-50FT	-



Hard-Drawn ACR Copper

O.D	20' Item #
3/8"	COP-ACR-037-20FT
1/2"	COP-ACR-050-20FT
5/8"	COP-ACR-062-20FT
3/4"	COP-ACR-075-20FT
7/8"	COP-ACR-087-20FT
1-1/8"	COP-ACR-112-20FT
1-3/8"	COP-ACR-137-20FT
1-5/8"	COP-ACR-162-20FT
2-1/8"	COP-ACR-212-20FT

Pre-Insulated Copper Tubing from **EBRILLE** INDUSTRIES

Available in 25', 50', and 164' Lengths

O.D	25' Roll Item #	50' Roll Item #	164' Roll Item #	Insulation R-Value	Wall Thickness
1/4"	COP-INS-025-025F	COP-INS-025-050F	COP-INS-025-164F	4.5	1/2"
3/8"	COP-INS-037-025F	COP-INS-037-050F	COP-INS-037-164F	4.0	
1/2"	COP-INS-050-025F	COP-INS-050-050F	COP-INS-050-164F		
5/8"	COP-INS-062-025F	COP-INS-062-050F	COP-INS-062-164F		
3/4"	-	COP-INS-075-050F	-		
7/8"	-	COP-INS-087-050F	-		

- Pre-insulated ASTM B280 copper tube
- Extruded closed-cell polyethylene foam
- Vapor Permeability $\mu \geq 11.000$ for the best anti-condensation performance
- 100% UV resistant aluminum outer jacket protects from direct sunlight
- Sealed at a pressure of over 70 for the perfect inner cleanliness of the tubes

Why use a 164' roll?

- Avoid excess scrap by cutting your exact needed size for each line.
- Avoid braze joints on longer line runs
- Create multiple linesets on VRF & multi-zone jobs



ZoomLock® Push Fittings

ZoomLock® PUSH

push-to-connect refrigerant fittings make clean, leak-free connections in seconds, without the use of a brazing torch or press tool and jaw. Rated for up to 870 psi (60 bar). No need to nitrogen purge; no fire hazards!

ZoomLock PUSH fittings eliminate brazing, flames, fire spotters, and the risks associated with installation of traditional HVAC/R fittings.

Straight Union		90° Elbow Union		Stub Tube x Flare Socket		Installation Kit & Disconnect Clips	
Part #	Size	Part #	Size	Part #	Size	Part #	Qty.
777133	1/4"	777143	1/4"	777139	1/4"	777091	Installation Kit w/ Depth Gauge, Marker, & Cleaning Pad
777134	3/8"	777144	3/8"	777140	3/8"		
777135	1/2"	777145	1/2"	777141	1/2"	777090	Removal Tools for 1/4" - 7/8" sizes
777136	5/8"	777146	5/8"	777142	5/8"		
777137	3/4"	777147	3/4"				
777138	7/8"	777148	7/8"				

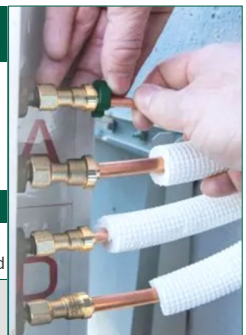

Nail Plates

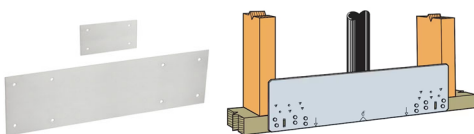

Nail Plates help prevent nails and screws from piercing pipes and electrical lines. They are typically placed over utilities that pass through framing members.

Item #	Size	Gauge	# of Holes	Case Qty.
NAIL-PLATE-3X6	3" x 6"	12ga.	12	25
NAIL-PLATE-6X12	6" x 612	12ga.	12	25
NAIL-PLATE-6X18	6" x 18"	16ga.	16	25

Copper Fittings

Copper Fitting Glossary

Type	Description
C	Coupling - Female fitting that slides over the pipe size
FTG	"Street" Fitting is exact pipe size - fits inside a coupling

Rolled Stop Coupling: C x C

Item #	Size	Pack Qty.
W01003	1/4"	100
W10142	5/16"	100
W01009	3/8"	100
W01017	1/2"	100
W01022	5/8"	100
W01028	3/4"	50
W01034	7/8"	50
W01047	1-1/8"	25
W01055	1-3/8"	10
W01063	1-5/8"	10
W01072	2-1/8"	6

Caps: C

Item #	Size	Pack Qty.
W07004	3/8"	100
W07006	1/2"	100
W07007	5/8"	100
W07008	3/4"	50
W07009	7/8"	50
W07011	1-1/8"	25
W07012	1-3/8"	5
W07013	1-5/8"	5
W07014	2-1/8"	5



Reducing Couplings C x C

Item #	Size	Pack Qty.
W01011	3/8" x 1/4"	100
W01019	1/2" x 3/8"	100
W01023	5/8" x 1/2"	100
W01025	5/8" x 3/8"	100
W01029	3/4" x 5/8"	50
W01030	3/4" x 1/2"	50
W01035	7/8" x 3/4"	50
W01036	7/8" x 5/8"	50
W01049	1-1/8" x 7/8"	25
W01050	1-1/8" x 3/4"	25
W01056	1-3/8" x 1-1/8"	25
W01058	1-3/8" x 7/8"	25
W01064	1-5/8" x 1-3/8"	10
W01065	1-5/8" x 1-1/8"	10
W01073	2-1/8" x 1-5/8"	15



Reducing Fittings FTG x C

Item #	Size	Pack Qty.
W01306	3/8" x 1/4"	100
W01312	1/2" x 3/8"	100
W01315	5/8" x 1/2"	100
W01317	5/8" x 3/8"	100
W01320	3/4" x 5/8"	50
W01321	3/4" x 1/2"	50
W01325	7/8" x 3/4"	50
W01326	7/8" x 5/8"	50
W01337	1-1/8" x 7/8"	25
W01338	1-1/8" x 3/4"	25
W01343	1-3/8" x 1-1/8"	25
W01345	1-3/8" x 7/8"	10
W01350	1-5/8" x 1-3/8"	10
W01351	1-5/8" x 1-1/8"	10
W01358	2-1/8" x 1-5/8"	15



Tees C x C x C

Item #	Size	Pack Qty.
W40306	1/4"	100
W04000	3/8"	100
W04001	1/2"	100
W04006	5/8"	50
W04017	3/4"	50
W04031	7/8"	25
W04048	1-1/8"	10
W04068	1-3/8"	10
W04084	1-5/8"	5
W40102	2-1/8"	1



90° Long Radius Elbow: C x C

Item #	Size	Pack Qty.
W02715	1/4"	100
W02710	5/16"	100
W02716	3/8"	100
W02717	1/2"	100
W02722	5/8"	50
W02728	3/4"	50
W02734	7/8"	25
W02747	1-1/8"	10
W02055	1-3/8"	10
W02063	1-5/8"	5
W02072	2-1/8"	1



90° Long Radius Street Elbow: C x C

Item #	Size	Pack Qty.
W02809	3/8"	100
W02817	1/2"	100
W02822	5/8"	50
W02828	3/4"	50
W02834	7/8"	25
W02847	1-1/8"	10
W02350	1-3/8"	10
W02355	1-5/8"	5
W02359	2-1/8"	1



45° Elbow C x C

Item #	Size	Pack Qty.
W03012	3/8"	100
W03021	1/2"	100
W03026	5/8"	50
W03030	3/4"	50
W03034	7/8"	25
W03044	1-1/8"	20
W03050	1-3/8"	10
W03055	1-5/8"	5
W03059	2-1/8"	1



FlareTite Gaskets

Used to prevent leaks on 45° flares. The locking tabs hold in place, and the coating prevents leaks up to 10,000psi.

Item #	Size	Pack Qty.
97216	(2) 1/4" x (2) 3/8"	
97215	(2) 1/4" x (2) 1/2"	4pk.
97214	(2) 1/4" x (2) 5/8"	
97212	(2) 3/8" x (2) 5/8"	2pk.
97211	(2) 3/8" x (2) 3/4"	
97210	Combo Kit: 9ea. of 1/4" - 5/8"	



Flare Fittings & Gaskets

Swivel Flare to Solder Adapter

Item #	Size	Pack Qty.
F2003	1/4"	
F2004	3/8"	4pk.
F2005	1/2"	
F2006	5/8"	2pk.
F2007	3/4"	



Flare Nuts

Item #	Size	Pack Qty.
DNS4-4	1/4"	
DNS4-6	3/8"	
DNS4-8	1/2"	10pk.
DNS4-10	5/8"	
DNS4-12	3/4"	



Brazing Alloys & Flux

Standard Brazing Rods

Application	Item #	Name	AG %	Details	Size
Copper-to-Copper, Brass, and Bronze.	95000	Fos-Flo®	0%	Economical, very fluid medium temp. filler metal. Withstands moderate vibration.	20" Rods 28 pk.
For copper-to-copper the phosphorus in the Sil-Fos serves as the fluxing agent.	95060	Sil-Fos® 5	5%	Ability to fill gaps and form fillets without affecting joint strength. Slow Flow.	20" Rods 28 pk.
For brass applications, separate flux is recommended.	95150	Sil-Fos® 15	15%	Highest joint ductility to withstand stresses in refrigeration applications. Slow Flow.	20" Rods 28 pk.
Flux-Coated Rod for Joining Dissimilar Metals	98100	Silvaloy® 452 Flux Coated (Blue)	45%	Joins ferrous, non-ferrous and dissimilar metals with large joint clearances.	18" Rods 8 pk.
	98120	Silvaloy® 560 Flux Coated (Orange)	56%	Lowest temperature filler. Very fluid alloy joins ferrous and non-ferrous metals.	18" Rods 8 pk.



Copper-to-Aluminum Brazing Rods

Brand	Item #	Name	AL %	Application	Details	Size
LucasMilhaupt	99088	Handy One®	22%	Aluminum-to-Copper & Aluminum-to-Aluminum	Flux-Cored Low-Temperature Brazing Rod: Melt @ 800°, Flow @ 900°	20" Rods 4 pk.
SOLDERWELD	SW-ALCU5.5	Al-Cop Braze™	22%	Aluminum-to-Copper Brazing	Low Melting Point and Narrow Melt Range: Recommended Brazing @ 950-1000°F	8" Rods 5 pk.
	SW-AS09305.5	Alloy Sol™	95%	Aluminum Repair and Joining Rod	For Aluminum Fittings, Tubing, and Coils: Recommended Brazing @ 600-700°F	8" Rods 5 pk.



Low Temp Dissimilar Metal Solder

Brand	Item #	Name	Application	Details	Size
SOLDERWELD	SW-MS09305K	Multi Sol™	Aluminum, Steel, Pot Metal, Copper, Brass, and Galvanized Steel	Tin-Zinc-Cadmium Multipurpose Solder: Recommended Brazing @ 250-500°F	18" Rods 5 pk.



Flux

Brand	Item	Description	Size
LucasMilhaupt	97030	Handy® Flux Liquid All Purpose Flux	7 oz. Jar
SOLDERWELD	SW-ASF1	Alloy Sol™ Flux Powdered Flux for Brazing Aluminum	1 oz. Jar
	SW-MSF2	Multi Sol Liquid Flux™ for Aluminum to Aluminum, Copper, and Most Dissimilar Metals	.7 oz. Bottle



SolderWeld® Kits

Item	Type	Contents
SW-ACRTC	Aluminum Repair Tech Bag	(5) 8" Alloy Sol Rods (5) 8" Alloy Cop Rod Alloy Sol Flux Wire Brush - Red Rag
SW-HVAK15	All-in-One Brazing Pack	(.5lbs.) 15% Sil Phos Rods (2) 56% Sil Sol Rods (5) 8" Alloy Cop Rods (5) 8" Alloy Sol Rods Alloy Sol Flux - Wire Brush



Brazing Gases

Type	Tank Size	Contents	Item #	Tank Item #
Acetylene	10 cu. ft.	GAS-MC	GAS-MC-TANK	
	40 cu. ft.	GAS-B	GAS-B-TANK	
Oxygen	20 cu. ft.	GAS-R20	GAS-R20-TANK	
MAP Pro	14 oz.	525-MT1	-	
Nitrogen	40 cu. ft.	GAS-N40	GAS-N40-TANK	
	225 cu. ft.	GAS-N225	GAS-N225-TANK	

Acetylene fuel can be used in oxy/acetylene brazing, or with air/acetylene torches

Oxygen provides a higher flame temperature than air/acetylene

Map Pro gas allows for the attachment of a portable torch handle that is much easier to handle than traditional brazing rigs

Nitrogen is used for purging/flushing lines, as well as avoiding copper oxide while brazing



Brazing Accessories

Flame Protection

Brand	Item	Description	Size
Nu-Calgon	4371-36	Thermo-Trap Protective Barrier Paste	11 oz.
	4371-32	Thermo-Trap Protective Barrier Gel	1 qt.
SOLDERWELD	SW-HB1	Hot Block Reusable Heat Absorption Putty	1 lb. Tub
	SW-MFRB	Flame-Resistant Magnetic Blanket	18" x 18"



Surface Preparation

Item	Description	Size
B-4	Welder's Brush w/ Stainless Steel Bristles	9"
B-10	Large Welder's Scratch Brush	14"
SC-10	Sandcloth - 120 Grit	1.5" x 30'
SCM-10	Open Mesh Sandcloth	1.5" x 30"
ACP-10	Abrasive Nylon Cleaning Pad: 10pk.	6.5" x 4.25"

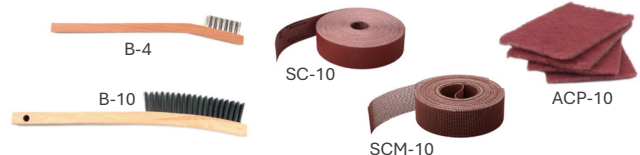

ZoomLock® Max Flame-Free Refrigerant Fittings

ZoomLock® MAX fittings, designed for the air conditioning and refrigeration markets, allow contractors to make secure leak-free connections in seconds. It means less time on the job and more money in the contractor's pocket. By eliminating concerns about gas and flames, ZoomLock MAX fittings offer more flexibility in where and when you can work, plus there's no need to nitrogen-purge the lines.

- Leak-proof connections for refrigerant lines up to 700 psi
- Hermetically sealed packaging for debris-free fittings
- Hard, robust copper fittings
- Proven three-point press technology providing a leak-free and secure joint
- No more crimp gauge needed - connect the fitting with one complete cycle
- Jaws available for most professional crimping tool brands, both large and compact

Reducers



Size	Item #	Size	Item #
3/8 x 1/4	870800	7/8 x 1/2	870812
1/2 x 1/4	870808	7/8 x 5/8	870804
1/2 x 3/8	870801	7/8 x 3/4	870805
5/8 x 1/4	870809	1-1/8 x 5/8	870814
5/8 x 3/8	870810	1-1/8 x 3/4	870806
5/8 x 1/2	870802	1-1/8 x 7/8	870807
3/4 x 1/2	870811	1-3/8 x 7/8	870815
3/4 x 5/8	870803	1-3/8 x 1-1/8	870816

Couplings



Size	Item #
1/4"	870508
3/8"	870509
1/2"	870503
5/8"	870510
3/4"	870505
7/8"	870506
1-1/8"	870507
1-3/8"	870511

45° Elbows



Size	Item #
1/4"	871401
3/8"	871402
1/2"	871403
5/8"	871404
3/4"	871405
7/8"	871406
1-1/8"	871407
1-3/8"	871399

90° Street Elbows



Size	Item #
3/8"	871302
1/2"	871303
5/8"	871304
3/4"	871305
7/8"	871306
1-1/8"	871307
1-3/8"	871308

90° Elbows



Size	Style	Item #
1/4"	Standard	870600
3/8"	Standard	870602
1/2"	Long Radius	871613
5/8"	Long Radius	871614
3/4"	Long Radius	871610
7/8"	Long Radius	871611
1-1/8"	Long Radius	871612
1-3/8"	Long Radius	871615

Installation Kit

Item #	Contents
870516	Depth gauge for sizes 1/4" to 1-1/8", permanent marker, and cleaning pad.



SAE Flares



Size	Item #
1/4"	871000
3/8"	871002
1/2"	871003
5/8"	871004
3/4"	871005

Caps



Size	Item #
1/4"	870900
3/8"	870902
1/2"	870903
5/8"	870904
3/4"	870905
7/8"	870906
1-1/8"	870907
1-3/8"	870908

Tees



Size	Item #
1/4"	870701
3/8"	870702
1/2"	870703
5/8"	870704
3/4"	870705
7/8"	870706
1-1/8"	870707
1-3/8"	870708

Rothenberger Press Tools

Item	Name	Force
871441	ROMAX® 4000	32kN
871439	Twin Turbo	24kN
871443	ROMAX® Compact	19kN



871439
871443

871441

ZoomLock recommends the use of Rothenberger press tools in combination with ZoomLock MAX jaws. However other press tools may be used with ZoomLock MAX Rothenberger jaws. Check online for tool compatibility.

Rothenberger Jaw Sets

Item	Name	Pieces
871408	MZK-32KN Jaw Kit	
871409	MZK-24KN Jaw Kit	(7): 1/4" to 1-1/8"
871410	MZK-19KN Jaw Kit	
871436	1-3/8" Jaw: Only for 32kN Press Tools	



871436



871408

Refrigerant Locking Caps

Item #	Description	Pack Qty.
CD2290	Corrosion Resistant Locking Caps	50
CD3830	Multi-Bit Tool for All Industry Standard Locking Caps	



Refrigerant locking caps fit over refrigerant access valves. They help prevent refrigerant theft or tampering. The CD Valve cap opens with a standard valve core tool.



Metal Lineset Covers

Item #	Description	Dimensions
LINECOVER-4X5X10	Lineset Cover w/Flat Cap	5" x 4" x 5" x 10'
LINECOVER-CAP	Angled Cap	5.25" x 4.75" x 7"

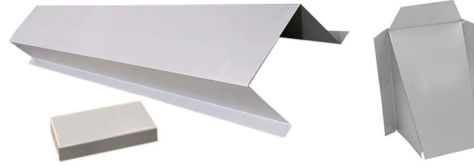

Angled Lineset Caps also serve as a great wall-mount lineset penetration cover

Wall Penetration Flashings

Item #	Description	Dimensions	Case Qty.
84006	Hinged Outset Seal	12" x 12"	4
83017	Telescoping Flex Wall Sleeve	3" x 5" - 7"	10

The **3" Telescoping Wall Sleeve** is used to create a clean sealed wall penetration for the HVAC interconnecting piping and cables.



83017



84006



The **Outset Seal** blocks air leakage, moisture, and rodent intrusion. The hinged style makes it perfect for retrofit or new construction.

Lineset Covers from COVER GUARD™

- Available in white, gray, or brown - are also paintable
- 4-stage adjustability accommodates multiple zone line sets and allows the duct to expand from 2" to 4".
- Components are paintable, UV stabilized, and tested to temperatures from -4° degrees F to 140° F.

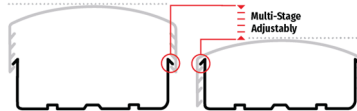

Prepackaged 12' Duct Kit - White Color

Item #	Contents		
CGKIT	(3) CGDUC - 4' Duct lengths (2) CGCUP - Couplings	(1) CGINLT - Wall Inlet (1) CGEND - End Cap	(1) CG90 - 90° Flat Elbow Cam Screws & Clips



Individual Components - White Color

78" Ducting		48" Ducting		Duct Coupler		Wall Inlet		End Fitting		90° Flat Elbow		90° Sweep Elbow		45° Flat Elbow		Flat Tee	
Part #	Qty.	Part #	Qty.	Part #	Qty.	Part #	Qty.	Part #	Qty.	Part #	Qty.	Part #	Qty.	Part #	Qty.	Part #	Qty.
CGDUC78	6	CGDUC	12	CGCUP	6	CGINLT	6	CGEND	6	CG90	6	CG90SWP	6	CG45	6	CGTEE	6

Large Flexible Elbow		Small Flexible Elbow		Flexible Adapter		Wall Flange for Flex		90° Inside Elbow		90° Outside Elbow		Soffit Inlet		Cam Screws		Duct Clips	
Part #	Qty.	Part #	Qty.	Part #	Qty.	Part #	Qty.	Part #	Qty.	Part #	Qty.	Part #	Qty.	Part #	Qty.	Part #	Qty.
CGFLXLR	6	CGFLXSM	6	CGFLXA	6	CGWLFL	6	CGINT90	6	CGEXT90	6	CGSTI	6	CGSCRW	50	CGCLP	25

Piping Insulation

1/2" Wall Thickness - 6' Sticks

Wall Size	Item #	Mfg. #	Tube O.D.	Case Qty.
1/2" Wall	INS-025-050	APT01412	1/4"	95
	INS-037-050	APT03812	3/8"	75
	INS-050-050	APT01212	1/2"	99
	INS-062-050	APT05812	5/8"	50
	INS-075-050	APT03412	3/4"	40
	INS-087-050	APT07812	7/8"	35
	INS-112-050	APT11812	1-1/8"	25
	INS-137-050	APT13812	1-3/8"	20



3/4" Wall Thickness - 6' Sticks

Wall Size	Item #	Mfg. #	Tube O.D.	Case Qty.
3/4" Wall	INS-062-075	APT05834	5/8"	24
	INS-075-075	APT03434	3/4"	23
	INS-087-075	APT07834	7/8"	20
	INS-112-075	APT13834	1-1/8"	15

1" Wall Thickness - 6' Sticks

Wall Size	Item #	Mfg. #	Tube O.D.	Case Qty.
1" Wall	INS-062-100	APT05810	5/8"	20
	INS-075-100	APT03410	3/4"	15
	INS-087-100	APT07810	7/8"	15
	INS-112-100	APT11810	1-1/8"	12
	INS-137-100	APT13810	1-3/8"	10
	INS-162-100	APT15810	1-5/8"	8
	INS-212-100	APT21810	2-1/8"	6



- GREENGUARD Gold Certified
- Microban® antimicrobial protection
- ASTM E 84 25/50 rated up to 2" wall
- Closed-cell foam structure prevents moisture wicking and eliminates need for additional vapor retarder

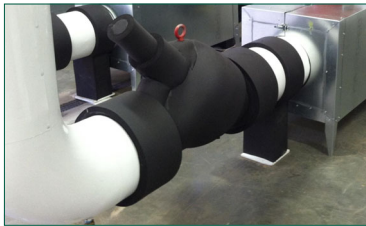

AP ArmaFlex® Sheets

Sheet Size	Item #	Mfg. #	Thickness	Case Qty.
3' x 4' Sheet	INS-SHEET-3X4X3/4	APS34043	3/4"	8
	INS-SHEET-3X4X1	APS10043	1"	6

UV Rated Insulation

ArmaFlex® Shield flexible foam insulation is a moisture and UV-resistant product with a durable protective jacket specially designed for line set, HVAC and refrigeration applications. Durable outer jacket resists damage due to sunlight, line trimmers, and other hazards.

6' Sticks

Wall Size	Tube O.D.	Item #	Mfg. #	Case Qty.
3/4" Wall	5/8"	INS-SHD-062-075-06	IPPCT05834	24
	3/4"	INS-SHD-075-075-06	IPPCT03434	24
	7/8"	INS-SHD-087-075-06	IPPCT07834	24
	1-1/8"	INS-SHD-112-075-06	IPPCT11834	15
1" Wall	5/8"	INS-SHD-062-100-06	IPPCT05810	20
	3/4"	INS-SHD-075-100-06	IPPCT03410	15
	7/8"	INS-SHD-087-100-06	IPPCT07810	15
	1-1/8"	INS-SHD-112-100-06	IPPCT11810	12

Bulk Boxes

Wall Size	Tube O.D.	Item #	Mfg. #	Box Qty.
3/4" Wall	5/8"	INS-SHD-062-075-60	IPPCT05834CL	60'
	3/4"	INS-SHD-075-075-40	IPPCT03434CL	40'
	7/8"	INS-SHD-087-075-40	IPPCT07834CL	40'
	1-1/8"	INS-SHD-112-075-35	IPPCT11834CL	35'
1" Wall	5/8"	INS-SHD-062-100-35	IPPCT05810CL	35'
	3/4"	INS-SHD-075-100-30	IPPCT03410CL	30'
	7/8"	INS-SHD-087-100-25	IPPCT07810CL	25'



TPO Rolled Mastic Sealant provides UV protection and a white impact resistant surface for lineset protection.

Item #	Thickness	Roll Width	Roll Length
326381	22 mil Composite	9"	75'

Piping Insulation Tapes & Adhesives



Item #	Description	Size	Qty.
INS-GLUE-08	ArmaFlex® 520 Adhesive w/ Brush Top	1/2pt.	24
VP410	UV Resistant Line Set Tape - Black	2" x 100'	24

Electrical Conduit & Connectors

Flexible Conduit

Item #	Conduit Size
750-12100	1/2" x 100'
750-34100	3/4" x 100'
750-10100	1" x 100'



Premade Liquid-Tite Conduit Whips

# of Wires	Item #	Conduit Size	Wire Size	Application	Pallet Qty.
3-Wire (Single-Phase)	B6-12-6NM	1/2" x 6'	10ga.	1.5 - 3.5 Ton Condensers	60
	B6-34-6NM	3/4" x 6'	8ga.	4 - 5 Ton Condensers	45

Liquid-Tite Non-Metallic Connectors

Type	Item #	Size	Box Qty.
Straight Connector	750-NMLT50	1/2"	25
	750-NMLT75	3/4"	10
	750-NMLT100	1"	5
90° Connector	750-NMLT9050	1/2"	10
	750-NMLT9075	3/4"	10
	750-NMLT90100	1"	5



One-Hole Conduit Clamps

Item #	Conduit Size	Pack Qty.
PI306	1/2"	20
PI307	3/4"	12
PI908	1"	10



Romex Connectors

Item #	Conduit Size	Pack Qty.
PI321	3/8"	8
PI320	3/8"	25
PI319	3/4"	4



Reducing Washers for Conduit Knockout Holes

Item #	Reduction	Pack Qty.
PI310	3/4" to 1/2"	28
PI304	1" to 1/2"	10
PI305	1" to 3/4"	10



Junction Boxes and Conduit Bodies

Steel Utility Boxes

Item #	L x W x D	Knockouts
PI361	4" x 2-1/8" x 2-1/8"	1/2"
PI363	4" x 4" x 2-1/8"	1/2" & 3/4"



Weatherproof Utility Boxes

Item #	Hole Size	L x W x D
PI385	1/2"	4" x 2-3/4" x 2"
PI385-34	3/4"	(Single Gang)
PI382	Weatherproof Blank Cover	

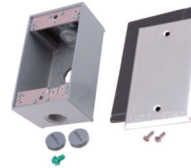

Utility Box Covers

Item #	Type	W x L
PI365	Toggle Switch	2-11/32" x 4-1/4"
PI367	Blank	(Single Gang)
PI377	Toggle Switch	4" x 4"
PI371	Blank	(Double Gang)



Rigid Conduit Bodies

Item #	Conduit Size	Includes
PI458	1/2"	Steel Cover, Screws, & Gasket
PI459	3/4"	



Aluminum Bodies can be use indoors or outdoors. Used to gain access to the interior of a raceway for wire pulling, and maintenance.

Surge Arrestors

Surge Arrestors protect valuable single-phase HVAC equipment by dissipating momentary voltage spikes and transient power surges. Power surges, no matter how minor, have a lasting effect on HVAC systems - wearing down compressors, damaging capacitors, and frying circuit boards.

Brand	Item #	Mfg. #	Voltage	Max Surge Protection	Mounting	H x D x W
ICM CONTROLS	ICM517A	-	120/240 1-Phase	100,000 amps	Disconnect	5" x 1.75" x 3.1"
	ICM530	-	208 Wye / 240 Delta 3-Phase	150,000 amps	Disconnect	4.3" x 2.3" x 4.1"
	ICM531	-	480 Delta / 277 Wye Three-Phase	150,000 amps	Disconnect	4.3" x 2.3" x 4.1"
RECTORSEAL	96415	RSH-50	120/240 1-Phase	50,000 amps	Disconnect	4.4" x 1.7" x 1.7"
	96414	RSH-120	120/240 1-Phase	120,000 amps	Main Panel	5.25" x 2.5" X 3"
	96422	Flush Mount Plate - for installing RSH-120 in a flush mount breaker panel (2pk.)				



Line Monitors



Line Monitors are ideal for inverter systems and ductless units. They protect against over and under voltage, short cycling, and high-power surges. They have programmable set points for safety cutoff when voltage is out of range. They also have history features to record power fault details.

Brand	Item #	Phase	Voltage	Features	H x W x D
RECTORSEAL	96421	Single	120v - 240v	· Built-In Surge Arrestor · Latching Relay Technology	11.8" x 8.5" x 5.8"
	96424	Single	120v - 240v	· Built-In Surge Arrestor & Disconnect · Latching Relay Technology	11.8" x 8.5" x 5.8"
ICM CONTROLS	ICM450+	Three	190v - 600v	· 3-phase voltages displayed on LCD · Monitors hi/low voltage, voltage imbalance, phase loss & reversal · 18v - 240v control input · Modbus RS485 comm. port	6.5" x 4.8" x 1.1"
	ICM492C-LF	Single	80v - 300v	18v - 240v Control Input for Thermostat Integration	3.2" x 3" x 1.4"
	ICM493	Single	180v - 264v	· 5 Built-In Surge Arrestors · 40a Contactor	7.6" x 8.3" x 4.4"
	ICM493-60	Single	195v - 264v	· 5 Built-In Surge Arrestors · 60a Contactor for 5-Ton Units	8.3" x 10.3" x 6.4"

Single-Phase Disconnects



Provides ON/OFF switching control for HVAC systems and mini-splits. Breaks both the power lines (L1 and L2) and the communication line of a mini-split's indoor unit for service.

3-Pole Disconnect Switch

Item #	Amps	Volts
755-303SW	30a	600v

Non-Fused Pull Disconnect with Pre-Installed Surge Arrestor

Item #	Amps	Volts	Surge Arrestor	Case Qty.
96419	60a	240v	RSH50	6



Non-Fused Pull Disconnects

Item #	Amps	Volts	D x W x H	Case Qty.
PD60NF	60a	240v	3.2" x 5.5" x 8.8"	6



Fused Disconnects have fuses located in an easy pull-out handle with indicator lights for blown fuses. Fuses not included.

Fused Pull Disconnects

Item #	Amps	Volts	D x W x H	Fuses	Case Qty.
DDS-30	30a	240v	2.7" x 5" x 7.5"	FLNR005 to 030	10
DDS-60	60a	240v	2.8" x 5.2" x 8.7"	FLNR035 to 060	10

Three-Phase Disconnects

240v 3-Phase Disconnects

Item #	Amps	Volts	Type	Fuses
DG322URB	60a	240v	Non-Fused	N/A
DG322NGB	60a	240v	Fusible	FLNR035 to 060
DG323NGB	100a	240v	Fusible	FLNR070 to 100
DG324NGK	200a	240v	Fusible	FLNR110 to 200

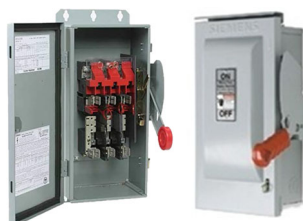

480v 3-Phase Disconnects

Item #	Amps	Volts	Type	Fuses
DH361URK	30a	600v	Non-Fused	N/A
DH361FRK	30a	600v	Fusible	FLSR005 to 030
DH362FRK	60a	600v	Fusible	FLSR035 to 060
DH363FRK	100a	600v	Fusible	FLSR070 to 100

Generator-Ready Disconnects

Quickly and easily run a ductless AC system during a power outage, using only a small portable generator. The compact DSS switch replaces the disconnect on the condenser, and provides an easily accessible port to plug in a small generator.

Item #	Amps	Volts
DSS-15	15a	120v
DSS-30	30a	240v



Fuses from Littelfuse®

Class RK5 / Class H Fuses - 250v

Amps	VAC	Item #	Littelfuse #	Bussman #
15	250	FUS02265	FLNR015	FRN-R-15
20	250	FUS02267	FLNR020	FRN-R-20
25	250	FUS02269	FLNR025	FRN-R-25
30	250	FUS02276	FLNR030	FRN-R-30
35	250	FUS01885	FLNR035	FRN-R-35
40	250	FUS01886	FLNR040	FRN-R-40
45	250	FUS01887	FLNR045	FRN-R-45
50	250	FUS01888	FLNR050	FRN-R-50
60	250	FUS01889	FLNR060	FRN-R-60
70	250	FUS02128	FLNR070	FRN-R-70
80	250	FUS01900	FLNR080	FRN-R-80
90	250	FUS00355	FLNR090	FRN-R-90
100	250	FUS01901	FLNR100	FRN-R-100
110	250	FUS00357	FLNR110	FRN-R-110
150	250	FUS01245	FLNR150	FRN-R-150
200	250	FUS00361	FLNR200	FRN-R-200



Class RK5 / Class H Fuses - 600v

Amps	VAC	Item #	Littelfuse #	Bussman #
10	600	FUS01893	FLSR010	FRS-R-10
15	600	FUS01637	FLSR015	FRS-R-15
20	600	FUS01895	FLSR020	FRS-R-20
25	600	FUS02266	FLSR025	FRS-R-25
30	600	FUS01642	FLSR030	FRS-R-30
35	600	FUS02281	FLSR035	FRS-R-35
40	600	FUS02278	FLSR040	FRS-R-40
45	600	FUS02268	FLSR045	FRS-R-45
50	600	FUS02249	FLSR050	FRS-R-50
60	600	FUS02263	FLSR060	FRS-R-60
70	600	FUS00415	FLSR070	FRS-R-70
80	600	FUS00417	FLSR080	FRS-R-80
90	600	FUS00922	FLSR090	FRS-R-90
100	600	FUS01906	FLSR100	FRS-R-100
110	600	FUS00420	FLSR110	FRS-R-110
125	600	FUS00421	FLSR125	FRS-R-125
150	600	FUS00422	FLSR150	FRS-R-150

Class RK5 / Class H 250v Fuse Blocks

Amps	Item #	Fits	Littelfuse #
30	LFR250303C	FLNR / FRN	LFR250303C
60	BLK00381	FLNR / FRN	LFR250603CID
100	BLK00382	FLNR / FRN	LFR251003CID



Class RK5 / Class H 600v Fuse Blocks

Amps	Item #	Fits	Littelfuse #
30	HLD00219	FLSR / FRS	LFR600303CID
60	BLK00388	FLSR / FRS	LFR600603CID
100	LFR601003CID	FLSR / FRS	LFR601003CID

250v Fuse Reducers

Item #	Clip Size	Fits Fuse
LRU263R	60 amp	5 - 30 amp
LRU216R	100 amp	35 - 60 amp



600v Fuse Reducers

Item #	Clip Size	Fits Fuse
LRU663R	60 amp	5 - 30 amp
LRU616R	100 amp	35 - 60 amp

JLLN / JJN Series - 300v Class T Fuses

Amps	VAC	Item #	Littelfuse #	Bussman #
40	300	FUS01780	JLLN040	JJN-40
60	300	FUS02301	JLLN060	JJN-60
80	300	FUS01711	JLLN080	JJN-80
150	300	FUS00905	JLLN150	JJN-150



JLLS / JJS Series - 600v Class T Fuses

Amps	VAC	Item #	Littelfuse #	Bussman #
30	600	FUS02297	JLLS030	JJS-30
40	600	FUS02298	JLLS040	JJS-40
50	600	FUS01252	JLLS050	JJS-50
60	600	FUS02299	JLLS060	JJS-60
70	600	FUS00944	JLLS070	JJS-70
80	600	FUS02300	JLLS080	JJS-80
90	600	FUS00945	JLLS090	JJS-90
100	600	FUS00703	JLLS100	JJS-100
125	600	FUS00906	JLLS125	JJS-125
150	600	FUS00907	JLLS150	JJS-150

JLLN - JJN / JLLS - JJS Fuse Blocks

Amps	VAC	Item #	Fits	Littelfuse #
60	300	BLK01139	JLLN / JJN	LFT300603C
100	300	HLD00582	JLLN / JJN	LFT301003CS
60	600	BLK00587	JLLS / JJS	LFT600603C
100	600	BLK00557	JLLS / JJS	LFT601003C



FLQ/FNQ Time-Delay Midget Fuses

Amps	VAC	Item #	Littelfuse #	Bussman #
15	500	FUS02274	FLQ015	FNQ-15
20	500	FUS02280	FLQ020	FNQ-20



SLC / SC Series - Class G Fuses

Amps	VAC	Item #	Littelfuse #	Bussman #
15	600	FUS01949	SLC-15	SC-15



LMF / GMF In-Line Series Fuses

Amps	VAC	Item #	Littelfuse #	Bussman #
3.2	300	FUS02295	LMF-3-2/10	GMF-3-2/10



SOO / S Series - Plug Fuses

Amps	VAC	Item #	Littelfuse #	Bussman #
3.2	125	FUS02246	SOO-3.2	S-3.2
6.25	125	FUS02283	SOO-6.25	S-6.25



GMF In-Line Fuse Holder

Item #	Littelfuse #	Bussman #
FUS02273	LHR	HLR



MDL Series Slo-Blo Time-Delay Fuses

Amps	VAC	Item #	Littelfuse #	Bussman #
1	250	FUS00207	313001	MDL-1
3	250	FUS02292	313003	MDL-3
5	250	FUS02288	313005	MDL-5



AGC Series Glass Fast-Acting Fuses

Amps	VAC	Item #	Littelfuse #	Bussman #
3	250	FUS02241	312003	AGC-3
5	250	FUS01529	312005	AGC-5
6	250	FUS02294	312006	AGC-6



Panel-Mount Fuse Holder for Glass Fuses

Item #	Littelfuse #	Bussman #
HLD00632	3453LF8A	HBH/HBV



GMD Series - 5mm x 20 mm Slo-Blo

Amps	VAC	Item #	Littelfuse #	Bussman #
3	250	FUS02291	0239003	GMD-3-R



ATO Series In-Line Fuse Holder

Item #	Littelfuse #	Bussman #
FUS02493	0FHA0001	HHD



ATO / ATC Series - Automotive Blade Fuses

Amps	VAC	Item #	Littelfuse #	Bussman #	Pack Qty.
3	32	626-AT0003	ATO-3	ATC-3	5
5	32	626-AT0005	ATO-5	ATC-5	5



Low-Voltage Circuit Breakers



The **Z-Breaker** has the same circuit breakers found on many high-end transformers. It includes wires and terminals for easily plugging in to the connectors where a fuse existed. A sticker is included so that the "reset" button can be easily identified, saving an emergency service call.

Item #	Amps
ZK003	3
ZK005	5

Power Cords



Item #	Length	Gauge	Description
625-16-6	6'	16/3	Bare Wire Power Cord - 110v
89006	2'	12/3	In-Line Tri-Tap Portable GFCI
ZD002			Fused Power Tap (Cheater) Cord - 120v

Electrical Hookup Wire (THHN)

Gauge	Color	Item #	Qty.
8 AWG	Black	W801	10' Pack
		W801-50	50' Roll
	Red	W802	10' Pack
		W802-50	50' Roll

Gauge	Color	Item #	Qty.
10 AWG	Black	W101	10' Pack
		W101-50	50' Roll
	Red	W102	10' Pack
		W102-50	50' Roll
	Green	W103	10' Pack
		W103-50	50' Roll
White	W105	10' Pack	

Gauge	Color	Item #	Qty.
12 AWG	Black	W121	15' Pack
	Red	W122	15' Pack
	Green	W123	15' Pack
	White	W125	15' Pack
14 AWG	Black	W141	20' Pack
	Red	W142	20' Pack
	Green	W143	20' Pack
	White	W145	20' Pack



Thermostat Wire (Solid Core)

General Purpose Thermostat Wire

Gauge / # of Wires	Item #	Mfg. #	Length
18/2	WIRE-18/2-500	47104807	500' Spool
	WIRE-18/2-500-BG	47105807	500' Bag
18/3	WIRE-18/3-500	47114807	500' Spool
	WIRE-18/3-250-BG	47115807	500' Bag
18/4	WIRE-18/4-250	47120307	250' Spool
	WIRE-18/4-250-BG	47120907	250' Bag
18/5	WIRE-18/5-250	47130307	250' Spool
	WIRE-18/5-250-BG	47130907	250' Bag
18/6	WIRE-18/6-250	47140307	250' Spool
	WIRE-18/6-250-BG	47140907	250' Bag
18/8	WIRE-18/8-250	47160307	250' Spool
	WIRE-18/8-250-BG	47160907	250' Bag
18/10	WIRE-18/10-250	47180307	250' Spool



Plenum-Rated Thermostat Wire

For code compliance in ductwork & plenum spaces

Gauge / # of Wires	Item #	Mfg. #	Length
18/2	WIRE-18/2-PL-500	47604812	500' Roll
18/3	WIRE-18/3-PL-500	47614812	500' Roll
18/4	WIRE-18/4-PL-250	47620312	250' Roll
18/5	WIRE-18/5-PL-250	47630312	250' Roll
18/6	WIRE-18/6-PL-250	47640312	250' Roll
18/8	WIRE-18/8-PL-250	47660312	250' Roll

Ductless / VRF Power & Communication Wire

14-Gauge / 4-Conductor wire is used for many ductless applications. The 4 conductors deliver both line voltage (power), and low-voltage (communications) from the condenser to the indoor head(s).

16/2 Shielded Stranded wire is often used in VRF systems for communication between the condenser, branch boxes, and indoor units. It can also be used for wired thermostats and sensors.

Gauge / # of Wires	Type	Item #	Mfg. #	Length
14/4	Stranded Black Tray Cable	WIRE-14/4-50	10703908	50'
		WIRE-14/4-250	10700108	250'
16/2	Shielded · Stranded · Plenum-Rated (Gray)	WIRE-16/2-SH-PL-250	32210112	250'



Generator Wire

Power and Control Wire Specific to Honeywell / Generac Generators: Wires are colored and numbered to match the Generac terminals. Direct Burial and UV Resistant Jacket. Available in different lengths of cable on reels (100', 250', 500', 1,000', 2,500')

NEC 2023 Code Compliant Neutral Wires: Blue/White (Battery) & Purple + Purple/Black (E-Stop)

Item #	Conductor Material	Generator kW Range	Max Breaker	3-Conductor (Power) Black - White - Red	1-Conductor (Ground) Green	9-Conductor (Control)	Length
CM-HSBCC-LRGPLUS2-JT84	Copper	17kW - 24kW	100A	3 AWG Cu	8 AWG Cu	18 AWG Cu (Black, Red, Yellow, Yellow/Black, White, Blue, Purple, Purple/Black, White/Blue)	100'
CM-HSBCC-ALUMPLUS2-JT93	Aluminum	17kW - 24kW	100A	1AWG Al	6 AWG Al		
CM-HSBCC-2361PLUS2	Copper	17kW - 26kW	125A	2 AWG Cu	6 AWG Cu		

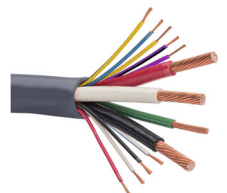

Building Automation Systems (BAS) Control Wire



Type	Item #	Mfg. #	Gauge	Wires	Color	Length	Application
	CAB01568		18	1 Pair	Purple	100'	Trane Symbio®
Shielded	WIRE-18/2-SH-PL-PU-1000	46522110	18	1 Pair	Purple	1000'	Trane® Spec Comm 3/4
Stranded	WIRE-18/2-SH-PL-NA-1000	32141112	18	2	Natural	1000'	Input-Output Sensor Wire
Plenum	WIRE-22/2-SH-PL-WH-1000	32541101	22	1 Pair	White	1000'	Echelon® Comm 5, LonWorks®
	WIRE-22/3-SH-PL-BL-1000	33242106	22	1.5 Pair	Blue	1000'	JCI®: EIA-485, BACnet®



Terminal Blocks and Polaris™ Connectors

Double-Row Terminal Blocks

Item #	Type	# of Poles	Amps	Wire Gauge	Image
TB3096-2	Open	2	30a	14 - 22ga.	
TB3096-4	Open	4	30a	14 - 22ga.	
TB3096-6	Open	6	30a	14 - 22ga.	
TB3096-8	Open	8	30a	14 - 22ga.	
ITB20-12	Insulated	12 (Cuts)	20a	12 - 22ga.	
ITB50-12	Insulated	12 (Cuts)	50a	8 - 20ga.	
TBS2-2	Open	2	75a	2 - 14ga.	
TBS2-3	Open	3	75a	2 - 14ga.	

Polaris™ Pre-Insulated Connectors

Image	Item #	Ports	Style	Wire Gauge
	ITD-4B	2	Dual Side	4 - 14ga
	ITD-2B	2	Dual Side	2 - 14ga.
	IPLD4-3B	3	Dual Side	4 - 14ga
	IPLD2-3B	3	Dual Side	2 - 14ga.

Polaris™ pre-insulated UL-rated connectors have setscrews that create weatherproof connections to tap and splice cables without special tools. The insulated housing protects the conductors against abrasion and chemical damage.

Wiring Terminals & Connectors

Winged Wire Nuts

Item #	Wire Gauge	Color	Box Qty.	Image
WWC-R-C	18 - 8	Red	100	
WWC-G-C	18 - 8	Gray	50	
WWC-B-C	14 - 6	Blue	50	



Wire Nuts

Image	Item #	Wire Gauge	Color	Box Qty.
	WC-B-C	22 - 14	Blue	100
	WC-O-C	22 - 14	Orange	100
	WC-Y-C	12 - 10	Yellow	100



ET-CP-12
ET-CP-13



MTK-2



THK

Assortments

Item #	Type	Contents	Total Qty.
ET-CP-12	Wire Nuts (Small Sizes)	(65) WC-O · (45) WC-Y · (30) WC-R · (40) WWC-T	180
ET-CP-13	Wire Nuts (Large Sizes)	(65) WC-O · (45) WWC-T · (50) WWC-Y · (30) WWC-R	185
MTK-2	Terminals	180pc. Assorted Vinyl Terminals with Crimper	180
THK	Heat Shrink	6" Sizes: 1/8" · 1/6" · 1/4" · 3/8" · 1/2" · 3/4"	94

Wiring Terminals & Connectors

Ring Terminals

Item #	Wire Gauge	Stud Size	Color	Pack Qty.	Image
R22-6V-S	22 - 18	#6	Red	25	
R22-8V-S	22 - 18	#8	Red	25	
R22-10V-S	22 - 18	#10	Red	25	
R16-6V-S	16 - 14	#6	Blue	25	
R16-8V-S	16 - 14	#8	Blue	25	
R16-10V-S	16 - 14	#10	Blue	25	
R12-8V-S	12 - 10	#8	Yellow	15	
R12-10V-S	12 - 10	#10	Yellow	10	
R12-14V-S	12 - 10	1/4"	Yellow	20	
R12-38V-S	12 - 10	3/8"	Yellow	10	



Spade Terminals

Image	Item #	Wire Gauge	Stud Size	Color	Pack Qty.
	S22-6V-S	22 - 18	#6	Red	25
	S22-8V-S	22 - 18	#8	Red	25
	S22-10V-S	22 - 18	#10	Red	25
	S16-6V-S	16 - 14	#6	Blue	20
	S16-8V-S	16 - 14	#8	Blue	20
	S16-10V-S	16 - 14	#10	Blue	20
	S12-8V-S	12 - 10	#8	Yellow	15
	S12-10V-S	12 - 10	#10	Yellow	15
	S12-14V-S	12 - 10	1/4"	Yellow	12



Butt Connectors

Item #	Wire Gauge	Color	Pack Qty.	Image
B22-V-S	22 - 18	Red	25	
B16-V-S	16 - 14	Blue	20	
B12-V-S	12 - 10	Yellow	15	







Heat Shrink Butt Connectors

Image	Item #	Wire Gauge	Color	Pack Qty.
	SB22	22 - 16	Red	25
	SB16	16 - 14	Blue	25
	SB12	12 - 10	Yellow	25

Male Disconnect Terminals

Item #	Wire Gauge	Style	Color	Pack Qty.	Image
M22-250-3V-S	22 - 18	Vinyl	Red	30	
M16-250-3V-S	16 - 14	Vinyl	Blue	30	
M12-250-3V-S	12 - 10	Vinyl	Yellow	25	
IM22-250-3N	22 - 18	Insulated	Red	50	
IM16-250-3N-S	16 - 14	Insulated	Blue	20	
IM12-250-3N	12 - 10	Insulated	Yellow	50	



Female Disconnect Terminals

Image	Item #	Wire Gauge	Style	Color	Pack Qty.
	F22-250-3V-S	22 - 18	Vinyl	Red	25
	F16-250-3V-S	16 - 14	Vinyl	Blue	25
	F12-250-3V-S	12 - 10	Vinyl	Yellow	10
	IF22-250-3N	22 - 18	Insulated	Red	50
	IF16-250-3N-S	16 - 14	Insulated	Blue	12
	IF12-250-3N-S	12 - 10	Insulated	Yellow	12

Female Flag & Compressor Terminals

Item #	Wire Gauge	Pack Qty.	Image
SF16-250-3-S	16 - 14	20	
SF12-250-3-S	12 - 10	15	
FCT12-250-3-S	12 - 8	15	

Fully Insulated Flag Terminals

Image	Item #	Wire Gauge	Pack Qty.
	IFL16-250-3N	16 - 14	50
	IFL12-250-3N-S	12 - 10	12

"Piggyback" Vinyl Adapters

Item #	Wire Gauge	Color	Pack Qty.	Image
P16-250-3V-S	16 - 14	Blue	15	
P12-250-3V	12 - 10	Yellow	50	

Double Male + Female Bare Adapters

Image	Item #	Type	Size	Pack Qty.
	DMT250-3-S	Flat	.250	15
	250-3MFM	Piggy-Back	.250	100
	250-3-Z	Chair	.250	100

Cable Ties & Mounting Accessories

Cable Ties

Item #	Length	Style	Color	Pack Qty.
DT4B	4"	Standard	Black UV	100
DT6B	8"	Standard	Black UV	100
DT11B	11"	Standard	Black UV	100
DT14B	14.5"	Standard	Black UV	100
DTM6B	8"	With Mounting Hole	Black UV	100
DTM14B	14.5"		Black UV	100
36 IN DUCT TIES	36"	Duct	Natural	50
48 IN DUCT TIES	48"	Duct	Natural	50



Wire Clamps & Grommets

Image	Item #	Description	Pack Qty.
	WCA1	Cable Clamp Assortment: 1/8" to 1"	26
	GVA1	1/4" to 1/2" Assortment	15
	GVA2	5/8" to 1" Assortment	5

Thermostat Mounting Accessories

Cover Plates / "Goof" Plates

Thermostat cover plates are a trim piece designed to cover any marks on the wall, previous mounting holes, or paint problems from removing the old thermostat.



Series	Item #	Fits	Color	H x W
Legacy Honeywell	50002883-001	FocusPRO® 5000 & 6000; PRO 3000 & 4000	White	(1) 5" x 6.9" (1) 6" x 8.3"
	32003796-001	Original Greenscreen VisionPRO® Series	White	5.5" x 7.9"
Current Honeywell	THP2400A1080	T1, T3, T4, & T6 Thermostats	White	6.1" x 6.1"
	THP2400A1019	RedLINK™ VisionPRO® or Wi-Fi VisionPRO®	White	5.7" x 6.2"
	THP2400A1027	Prestige® IAQ & WIFI 9000 Thermostat	White	(1) 4.3" x 5.5" (1) 5" x 6.9"
Trane	BAYCOVR800A	Trane TCONT624, 724, 824, & 850	Silver	6" x 7.4"



Thermostat Guards

Thermostat guards prevent damage, tampering, and unauthorized access to the system settings. These clear plastic guards allow visibility to the control screen while still restricting access.

Item #	Exterior H x W x D	Interior H x W
TG511A1000	6.5" x 7.5" x 2.9"	5" x 6"
TG512A1009	7.25" x 9.75" x 3.3"	5.9" x 8.3"

Thermostat Wire Reduction



The **Magnetic Mount C-Wire Adapter Kit** is designed to be used with W-Fi and other modern thermostats in which a 24v "C" wire is required, but the existing control does not C wire connected or available. The wire saver acts like a splitter, and replaces the need for a C wire to be run from the HVAC system to the thermostat.

Item #	Wires In	Wires Out
THP9045A2098	4 Wires (no C)	5 Wires

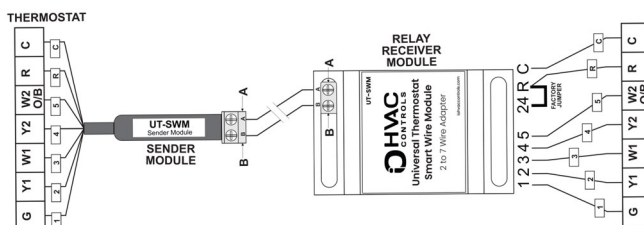

The **Smart Wire Module** is a 2-7 wire adapter which allows you to add up to 5 additional outputs over a single pair of wires between two locations such as a thermostat and HVAC system. This product saves the time and effort of having to pull new wire in situations where additional wires are needed.

Item #	Wires In	Wires Out
UT-SWM	2 Wires	Up to 7 Wires

Trane Connected Thermostats

Connect your system to the app so you can set temperature, adjust schedules, and monitor your HVAC usage from virtually anywhere. With Z-wave, control your locks, lights, cameras, and more from one central platform.

Diagnostics: When setup, the dealer can see temperature and humidity statistics, set points and scheduling. The dealer will also receive system alerts, including maintenance reminders and system malfunctions.

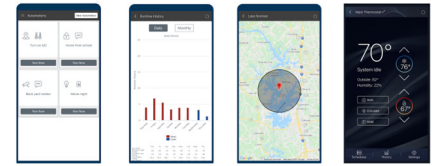

24v Programmable Thermostats

Item #	Stages	Display	Wi-Fi	Z-Wave	Aux. Relays (Vent / Dehum)	BK Terminal	Remote Sensor Capable
TCONT724AS42DA	4H / 2C	4.3" B & W	Yes	No	1	Yes	Wired
TCONT824AS52DC	5H / 2C	4.3" Color	Yes	Yes	2	Yes	Wired & Wireless



TCONT724

TCONT824

Advanced Dehumidification with the BK Terminal

The 724 & 824 utilize air flow reduction (only with variable speed blowers) when the BK terminal is connected. When the indoor RH is higher than the cooling RH target, the system will reduce air flow by 30%. Air flow reduction stops if the temperature is more than 2°F above the cooling setpoint.

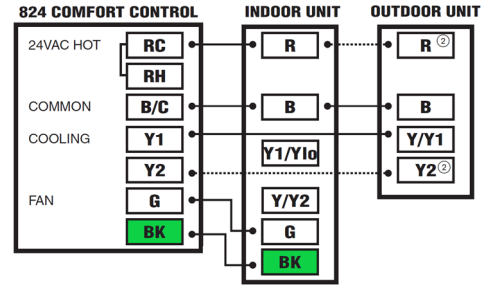

Communicating Thermostats

24v controls use simple "on/off" signals between the thermostat and HVAC components. Communicating systems allow for back-and-forth transmission of data between the various parts of the HVAC system. This enables the different components to optimize performance based on conditions and system performance, often greatly improving efficiency.

Item #	Platform	Stages	Display	Wi-Fi	Z-Wave	Aux. Relays (Vent / Dehum)	Remote Sensor Capable
TLINK360A2VVUD	Trane® Link	5H / 2C	7" Color	Yes	No	No	Wired & Wireless
TZON1050AC52ZB	ComfortLink™ II	5H / 2C	7" Color	Yes	Yes	w/ BAY24VRPAC52DB	Wired & Wireless
TCONT850AC52UB	ComfortLink™ II	5H / 2C	4.3" Color	Yes	Yes	w/ BAY24VRPAC52DB	Wired & Wireless
BAY24VRPAC52DC	24v Relay Panel: with AUX Contacts for Dehumidification, Ventilation, and Sensors						



BAY24VRPAC52DC

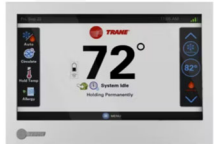

TLINK360 with Controller



TZON1050



TCONT850

Trane Pivot® Commercial Thermostat

The Pivot® Smart Thermostat System provides professional-level features greater than typical 24v controls. The mobile app can control multiple buildings, and can grant specific users and devices access to the system. Pivot® integrates with Tracer® Ensemble, to integrate buildings with only thermostat-controlled equipment into a full BAS system.

The Pivot contractor portal establishes a link between your building and the preferred service provider. Once a contractor is granted access, they can view the system status and alerts, and troubleshoot remotely.

Item #	Platform	Stages	Display	Wi-Fi	Z-Wave	Aux. Relays (Vent / Dehum)	Remote Sensor Capable
TCONT830AS52DA	Trane® Pivot®	5H / 2C	7" Color	Yes	No	2	Wired



Trane Thermostat Remote Sensors

Item #	Description	Display	Wiring
ZZSENSAL0400AA	10K Ohm Temperature Sensor	None	Wired
ZSENS930AW00MA	Temp & RH Sensor	None	Wireless



ZZSENSAL0400

ZSENS930



PRO1 Thermostats



The PRO1 free private-label system makes it easy to apply your logo and information in the field.

Item #	Stages	Display Size	Type	Change Over	Wi-Fi	Aux. Relay for Dehum	Case Qty.
T701	1H / 1C	4"	Non-Programmable	Manual	No	No	10
T721	2H / 1C	4"	Non-Programmable	Manual	No	No	10
T705	1H / 1C	4"	7-Day Programmable	Manual	No	No	10
T725	2H / 1C	4"	7-Day Programmable	Manual	No	No	10
T721i	2H / 1C	7"	7-Day Programmable	Auto	Yes	No	10
T855iSH	5H / 3C *	8"	7-Day Programmable	Auto	Yes	Yes	10

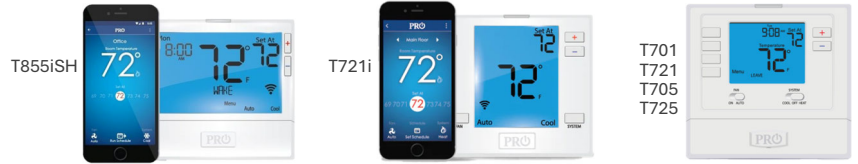

Honeywell Thermostats

Non-Connected (Non Wi-Fi) Thermostats

Series	Item #	Stages	Display Size	Type	Change Over	Aux. Relay for Dehum/Vent	Sensor Capable	Case Qty.	Replaces
N100	TH1110U4000	1H / 1C	4"	Non-Programmable	Auto	No	No	12	TH1110E1000, TH1110D2009, TH3110U2008, TH5110D1006, TH5110D1022
	TH1320U4002	3H / 2C *	4"	Non-Programmable	Auto	No	No	12	TH3210D1004, TH3210U2004, TH5220D1003, TH5220D1029
E1	TH1110E1000	1H / 1C	3.3"	Non-Programmable	Manual	No	No	12	Phasing Out Replaced by N100 Series TH1110U4000 & TH1320U4002
T1	TH1110D2009	1H / 1C	2.4"	Non-Programmable	Manual	No	No	12	
T3	TH3110U2008	1H / 1C	3.3"	Non-Programmable	Auto	No	No	12	
	TH3210U2004	2H / 1C	3.3"	Non-Programmable	Auto	No	No	12	
P200	TH2110U4004	1H / 1C	4.8"	7-Day Programmable	Auto	No	No	12	TH4110U2005, TH6110D1005, TH6110D1021
	TH2320U4006	3H / 2C *	4.8"	7-Day Programmable	Auto	No	No	12	TH4210U2002, TH6220D1002, TH6220D1028
T4	TH4110U2005	1H / 1C	3.9"	7-Day Programmable	Auto	No	No	12	Phasing Out Replaced by P200 TH2110U4004 & TH2320U4006
	TH4210U2002	2H / 1C	3.9"	7-Day Programmable	Auto	No	No	12	
T6	TH6210U2001	1H / 1C	5.4"	7-Day Programmable	Auto	No	No	12	TH6110D1005, TH6110D1021
	TH6220U2000	2H / 2C	5.4"	7-Day Programmable	Auto	No	Wired	12	TH6220D1002, TH6220D1028
	TH6320U2008	3H / 2C *	5.4"	7-Day Programmable	Auto	No	Wired	12	TH6320U1000, TH6320U1001
	C7189U1005	Wired Remote Indoor Sensor - for remote sensing or averaging - 10K ohm							



N100 / P200 / S200 Snap-On Trim



Honeywell Thermostat Private Label Options

The new N100 / P200 / S200 series feature a field-installed snap-on private label trim plate. This makes it easy to quickly personalize an off-the-shelf thermostat.

All other Honeywell Home Thermostats can be ordered with custom-imprinted information.

Honeywell Smart (Wi-Fi) Thermostats

Smart (Wi-Fi) Thermostats

Series	Item #	Stages	Display Size	Type	Change Over	Aux. Relay for Dehum/Vent	Sensor Capable	Case Qty.
S200	TH2110WF4008	1H / 1C	4.8"	7-Day Programmable	Auto	No	No	12
	TH2320WF4010	3H / 2C *	4.8"	7-Day Programmable	Auto	No	No	12
T6	TH6220WF2006	2H / 2C	6.9"	7-Day Programmable	Auto	No	Wired	12
	TH6320WF2003	3H / 2C *	6.9"	7-Day Programmable	Auto	Ventilation	Wired	12
8000	TH8321WF1001	3H / 2C *	10"	7-Day Programmable	Auto	Dehum / Vent	Wired	12
9000	TH9320WF5003	2H / 2C	8" Color	7-Day Programmable	Auto	No	No	12
C7189U1005		Wired Remote Indoor Sensor - for remote sensing or averaging - 10K ohm						



S200



T6



TH8321WF1001



TH9320WF5003



C7189U1005

T10+ Smart (Wi-Fi) Thermostats w/ Wireless Room Sensors

The **T10+ system** works in conjunction with up to 20 indoor temperature/humidity/ motion sensors. They can be used in combination for temperature averaging, or individually. These devices also sense motion - allowing you to prioritize specific rooms through scheduling, or prioritizing comfort in active spaces using built-in motion detection.

Series	Item #	Stages	Display Size	Type	Change Over	Aux. Relay for Dehum/Vent	Sensor Included	Case Qty.
T10+	THX321WF3003W	3H / 2C *	7.2"	7-Day Programmable	Auto	Dehum / Vent	No	12
	THX321WFS3001W	3H / 2C *	7.2"	7-Day Programmable	Auto	Dehum / Vent	1 Included	12
C7189R3002-2		Additional T10+ Room Sensors: 2 pack (up to 20 can be paired with a T10+ thermostat)						



THX321WF3003W



C7189R3002-2

Z-Wave Connected Thermostats

Series	Item #	Stages	Display Size	Power	Type	Change Over	Case Qty.
T6	TH6320ZW2007	3H / 2C *	6.9"	Battery or C-Wire	7-Day Programmable	Auto	12

The **T6 Pro Z-Wave** works with any Z-Wave-compatible controller, hub, and gateway to control the home's HVAC system as well as other Z-Wave devices connected to the same controller.



Honeywell RedLINK® Platform Thermostats

The RedLINK® wireless platform allows for easy integration of dehumidification, ventilation, indoor air quality and zoning systems - without running new wires. The thermostat offers selectable light commercial settings, making this a versatile control for both homeowners and building operators.



Residential or Commercial Setup Options

Series	Item #	Stages	Display Size	Type	Change Over	Aux. Relay for Dehum/Vent	Sensor Capable	Case Qty.
8000	TH8110R1008	1H / 1C	10"	7-Day Programmable	Auto	No	Wired & Wireless	12
	TH8320R1003	3H / 2C *	10"	7-Day Programmable	Auto	No	Wired & Wireless	12
	TH8321R1001	3H / 2C *	10"	7-Day Programmable	Auto	Dehum / Vent	Wired & Wireless	12



* Dual Fuel (Heat Pump + Furnace) Compatible

RedLINK® Prestige® IAQ Control

Full Color Thermostat with Powerful EIM Board Capabilities

The Prestige® IAQ system only requires two wires between the thermostat and the EIM board. The EIM board provides powerful capabilities, including supply/return duct sensors for Delta T diagnostics and alerts, three sets of IAQ contacts for dehumidification and ventilation, and four sensor inputs for wired sensors or dry contact devices.

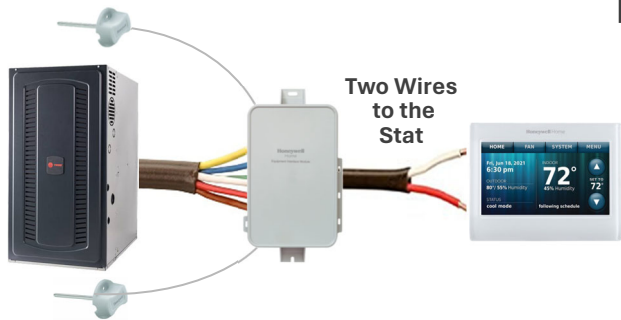

Two Wires to the Stat

Item #	Contents
YTHX9421R5085WW	THX9421R5021WW Prestige® 2-Wire IAQ Thermostat
YTHX9421R5127WW	THM5421R1021 Equipment Interface Module, 2 Duct Sensors
	Items above, plus THM6000R7001 Internet Gateway

RedLINK® Thermostat Wire Elimination

Wireless from the Thermostat to the Indoor Equipment

Mount a battery-operated TH8110 / TH8320 / TH8321 RedLINK® Thermostat with no thermostat wire! Mount the Equipment Interface Module (EIM) at the air handling unit, and it communicates wirelessly with the thermostat.



No Wires Between the Thermostat and AHU!

ERM5220R1018

Item #	Description
THM5421R1021	RedLINK® Equipment Interface Module
YTHM5421R1010	Equipment Interface Module w/ (2) Duct Sensors
TH8110R1008	RedLINK® 1H / 1C Thermostat
TH8320R1003	RedLINK® 3H / 2C Thermostat
TH8321R1001	RedLINK® 3H / 2C Stat w/ Dehum

Wireless from the Condenser to the Indoor Equipment

Eliminate the need to run wires from a single or two-stage condensing unit to the inside equipment! Place the Equipment Remote Module (ERM) at the condenser, and wire a TH8110 / TH8320 / TH8321 RedLINK® Thermostat to the indoor equipment.



No Wires Between the Condenser and AHU!

ERM5220R1018

Item #	Description
ERM5220R1018	RedLINK® Equipment Remote Module
TH8110R1008	RedLINK® 1H / 1C Thermostat
TH8320R1003	RedLINK® 3H / 2C Thermostat
TH8321R1001	RedLINK® 3H / 2C Stat w/ Dehum

RedLINK® Accessories

Use the Wireless Adapter to extend RedLINK® wireless range. Highly recommended in commercial rooftop installations. Connects to the EIM Board.

Item #	Function
THM4000R1000	Wireless Adapter for use with RedLINK® enabled thermostats

Wireless Accessories



REM5000R1001

C7089R1013

C7189R1004

Item #	Function
REM5000R1001	Portable Comfort Control - For Managing Multiple Stats & Remote Sensing
C7089R1013	Wireless Outdoor Air Sensor - For Displaying Outdoor Temp & Humidity
C7189R1004	Wireless Indoor Air Sensor - For Remote Sensing or Averaging



The RedLINK® Internet Gateway is required for App control. Manage the RedLINK® system using the Total Comfort Connect App by connecting this gateway to a customer-supplied internet router.

Item #	Function
THM6000R7001	Internet Gateway with Ethernet Cable and Power Cord

Zoning Systems

Zoning allows homes or buildings to use a single HVAC system, but divides the space into separate temperature zones, which provides room-to-room control. This is accomplished by placing a thermostat in each zone. That thermostat then signals a damper in the ductwork feeding that area. The damper opens and closes to control the flow of conditioned air. With zoning, only areas needing conditioned air get it, while areas that are already satisfied do not.

24v Zoning Systems from **Honeywell Home**

Honeywell Home Zone Systems are designed to work with 24v conventional systems. They will not work with communicating controls.

Several of Honeywell's zoning boards employ RedLINK® wireless technology - allowing for the use of wireless zone thermostats. This is a game-changer for retrofit zoning jobs. You can avoid pulling new thermostat wires in an existing building when using RedLINK® zoning.



HZ432K

Main Zone Boards

Item #	Zones	Variable Speed Control?	Stages	Supports Wireless Thermostats?	Dimensions W x H x D	Includes
HZ311K	3	Yes - BK/DS Terminal	1H / 1C	No	8" x 8.5" x 1.9"	40va Transformer (AT140A100)
HZ322K	3	Yes - BK/DS Terminal	2H / 2C	Yes - with THM4000	8" x 11.5" x 1.9"	Discharge Sensor (C7735A1000)
HZ432K	4	Yes - BK/DS Terminal	3H / 2C	Yes - with THM4000	8" x 13.5" x 1.9"	

Optional Additional Boards

Item #	Function	Dimensions W x H x D
THM4000R1000	Wireless Adapter for Wireless Zone Thermostats	
TAZ-4H	Adds up to (4) Additional Zones to HZ432	8" x 13.5" x 1.9"

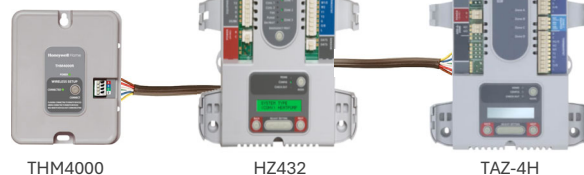

THM4000

HZ432

TAZ-4H

Zone Dampers

The TrueZONE® Damper is a two-position, 24-VAC, power-close, spring-return damper with a built-in actuator.

- Adjustable Range Stops
- Mechanical Position Indicator
- LED Open/Close Indicator Lights (3-wire applications)

Round Dampers

Size	Item #	Size	Item #
5"	ARD5TZ	12"	ARD12TZ
6"	ARD6TZ	14"	ARD14TZ
7"	ARD7TZ	16"	ARD16TZ
8"	ARD8TZ	18"	ARD18TZ
9"	ARD9TZ	20"	ARD20TZ
10"	ARD10TZ		



Rectangular Dampers



More than 120 options from 6" x 6" to 24" x 24". Call Hunton Distribution with your specific size requirements.

Replacement Actuator

Fits all ARD Dampers

Item #
M847D-ZONE



Bypass Dampers

The TrueZONE® Bypass constant pressure regulating damper (CPRD) is a round static pressure relief damper. It is used in forced-air bypass applications to relieve excess static pressure when some of the zone dampers are closed. The damper is installed in a duct that delivers air to the return or a dump zone. The damper automatically opens and closes to maintain a desired static pressure.

Size	Item #
8"	CPRD8
10"	CPRD10
12"	CPRD12
14"	CPRD14

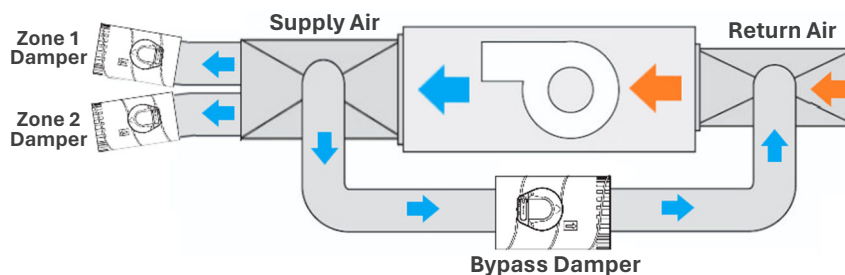

Bypass Damper

Honeywell Zoning Selection Worksheet

1) Going wireless? Not pulling wire to any zone thermostats? Adding wireless sensors?

If you are wirelessly connecting to a zone controller or accessory, you must add a THM4000R1000 wireless adapter. You must also select a HZ322K or HZ432K in step 2.



Item #	Qty.
THM4000R1000	

2) Select the TrueZONE® Panel

For RedLINK® wireless compatibility select either the HZ432K or HZ322K.



Item #	Zones	Supports Wireless Thermostats?	Qty.
HZ311K	3	No	
HZ322K	3	Yes - with THM4000	
HZ432K	4	Yes - with THM4000	
TAZ-4H	+ 4	Add-A-Zone Panel	

3) Select Zone Dampers

Select a damper for each zone.



Size	Item #	Qty.
5"	ARD5TZ	
6"	ARD6TZ	
7"	ARD7TZ	
8"	ARD8TZ	

Size	Item #	Qty.
9"	ARD9TZ	
10"	ARD10TZ	
12"	ARD12TZ	
14"	ARD14TZ	

Size	Item #	Qty.
16"	ARD16TZ	
18"	ARD18TZ	
20"	ARD20TZ	

4) Calculate Bypass CFM for the System

Identify the smallest zone to determine the maximum amount of supply air to bypass.

Total System CFM	minus	CFM of smallest zone	equals	Total CFM to bypass
	—		=	



5) Select the Bypass Damper

Using the bypass CFM calculation from step 4, select the system bypass damper

Size	Bypass CFM	Item #	Qty.
8"	Up to 600 CFM	CPRD8	
10"	600 - 1,000 CFM	CPRD10	
12"	1,000 - 1,400 CFM	CPRD12	
14"	Over 1,400 CFM	CPRD14	

6) Select a Thermostat for Each Zone

Standard 24v stats can be used.



THX9421R5021WW



TH8320R1003

Item #	Wiring	Qty.
THX9421R5021WW	Red/Common Wire Needed	
TH8320R1003	Wired or Wireless	

7) Select Optional Wireless Accessories

a THM4000R1000 must be selected in step 1.



THM5421R1021



THM6000R7001



C7089R1013

Item #	Function	Qty.
THM5421R1021	EIM Board - For Controlling Dehumidifier / Fresh Air	
THM6000R7001	RedLINK® Internet Gateway - Control System with the TCC App	
C7089R1013	Wireless Outdoor Sensor - to display outdoor readings on stats	

ComfortLink™ II Zoning for Trane® 24v Systems

Trane ComfortLink™ II Zoning can only be applied with a 24v Trane variable speed indoor AHU or furnace. **Only contractors that have been certified in Trane Zoning installation may install these systems.** Trane's zoning systems do not utilize a bypass damper. Instead, Trane zoning systems automatically set maximum CFM per zone, and power open / power close modulating dampers to provide comfort and proper airflow.

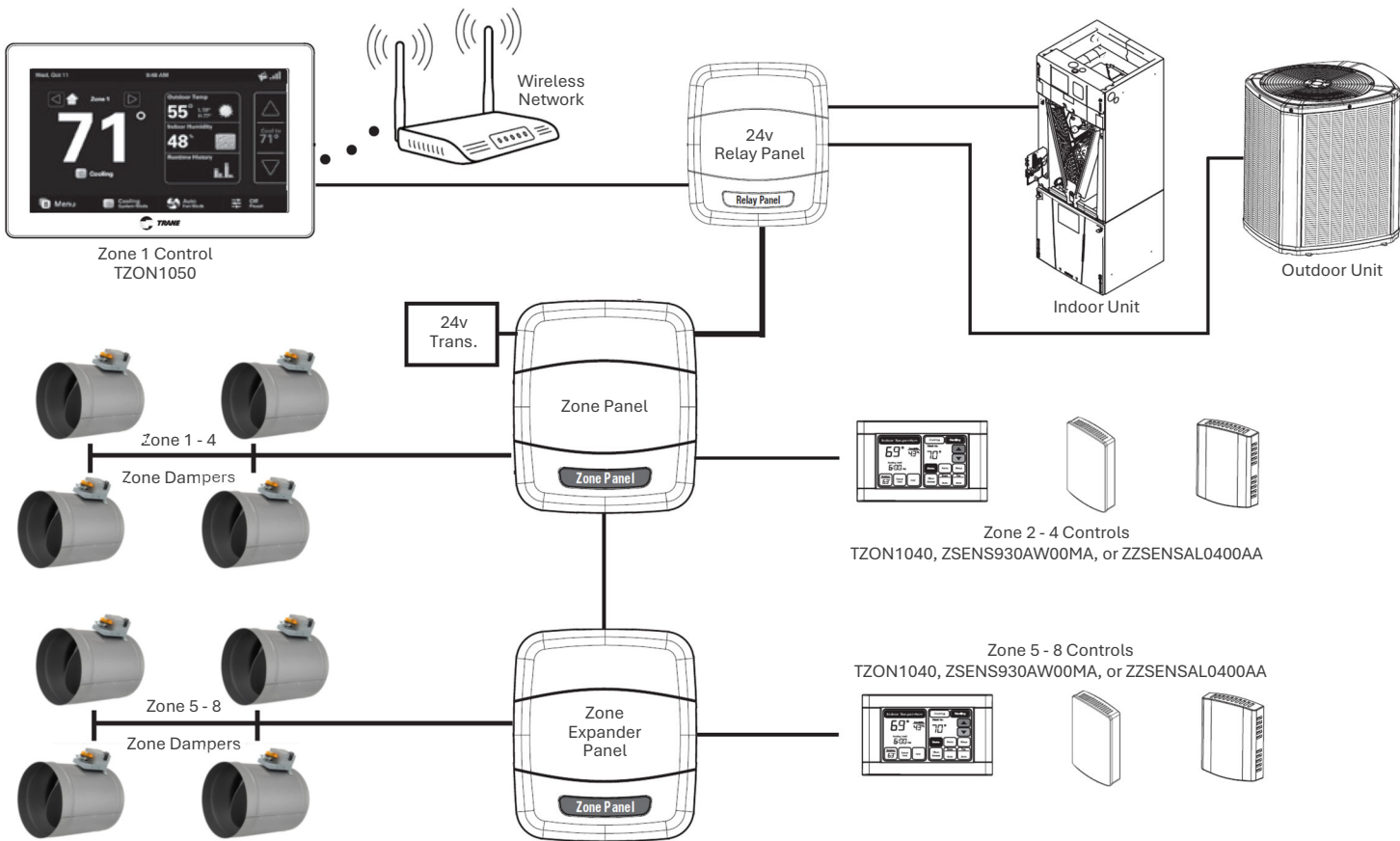

ComfortLink II Panels

Item #	Description
BAY24VRPAC52DC	24v Relay Panel
ZZONEPNLAC52ZB	ComfortLink™ II Zone Panel w/ SP Probes, DAT Sensor, Tubing & Transducer
ZZONEEXPAC52ZB	ComfortLink™ II Zone Expander Panel

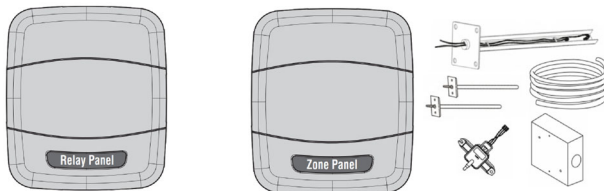

ComfortLink II Controls & Sensors

Item #	Description	Display	Wiring
TZON1050AC52ZC	XL 1050	7" Color	Wired
TZON1040AC52ZB	XL 1040	4.3" Color	Wired
ZZSENSAL0400AA	Temperature Sensor	None	Wired
ZSENS930AW00MA	Temp. & Humidity Sensor	None	Wireless



Dampers

Size	Item #
6"	ZDAMPRDMA0006A
7"	ZDAMPRDMA0007A
8"	ZDAMPRDMA0008A
9"	ZDAMPRDMA0009A
10"	ZDAMPRDMA0010A
12"	ZDAMPRDMA0012A
14"	ZDAMPRDMA0014A
16"	ZDAMPRDMA0016A
18"	ZDAMPRDMA0018A
20"	ZDAMPRDMA0020A

- 24v Power open/Power close
- 3-wire connection - 18 gauge
- 60 second travel time



Trane® LINK Zoning for Communicating Systems

Trane® Link Zoning can only be applied with a communicating Trane Link variable speed indoor/outdoor system. **Only contractors that have been certified in Trane Zoning installation may install these systems.** Trane's zoning systems do not utilize a bypass damper. Instead, Trane zoning systems automatically set maximum CFM per zone, and power open / power close modulating dampers to provide comfort and proper airflow.

Trane® Link Zoning requires a transformer sizing calculation. Most smaller zone systems will not require a secondary transformer. Larger systems will require a secondary transformer is required to power the zoning components that will be connected to a 8X distribution board.

Minimal 3-Zone System Example

Where transformer sizing does not require a secondary transformer

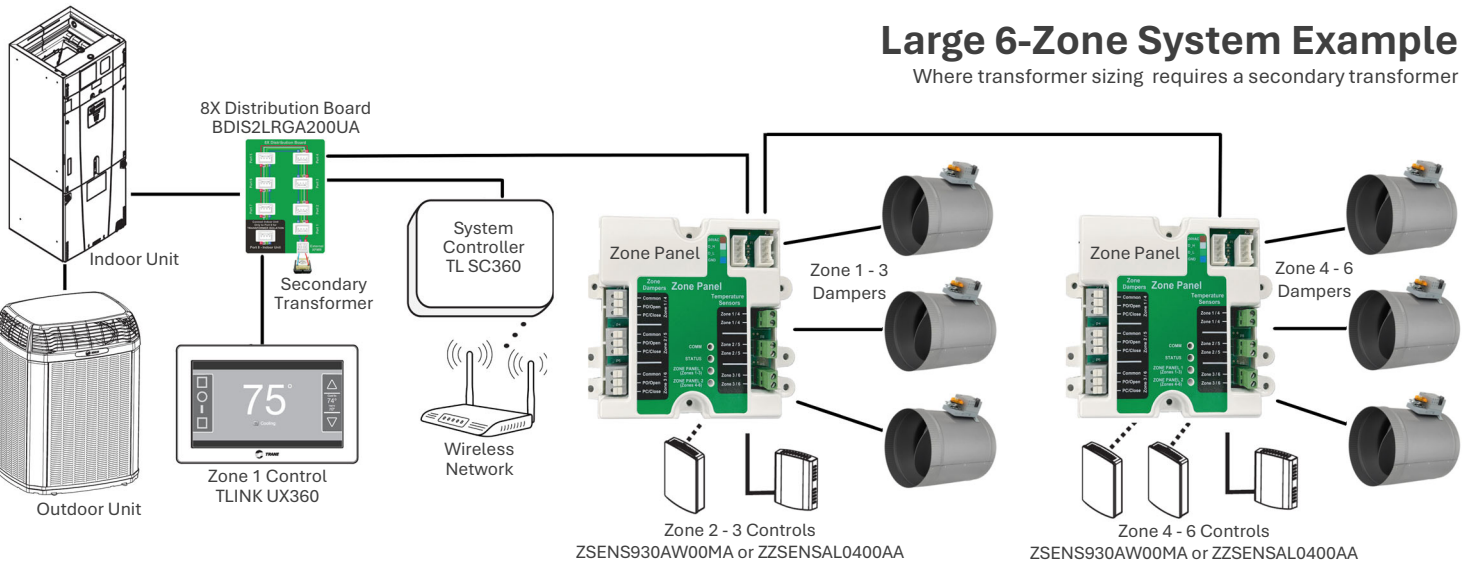
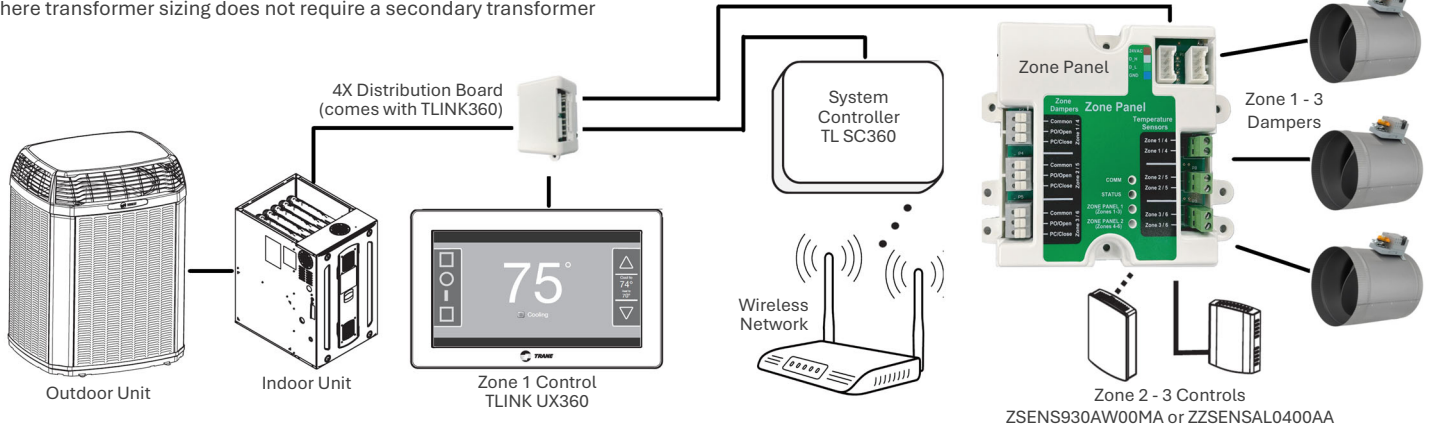

Large 6-Zone System Example

Where transformer sizing requires a secondary transformer

Dampers

Size	Item #
6"	ZDAMPRDMA0006A
7"	ZDAMPRDMA0007A
8"	ZDAMPRDMA0008A
9"	ZDAMPRDMA0009A
10"	ZDAMPRDMA0010A
12"	ZDAMPRDMA0012A
14"	ZDAMPRDMA0014A
16"	ZDAMPRDMA0016A
18"	ZDAMPRDMA0018A
20"	ZDAMPRDMA0020A



Trane® LINK Panels & Boards

Item #	Description
ZZON2PNLA200ZA	3-Zone Trane® Link Zone Panel
BDIS2LRGA200UA	Trane® 8X CAN Bus Distribution Board

Trane® LINK Controls & Sensors

Item #	Description	Display	Wiring
TLINK360A2VVUD	Communicating Controller & Stat	7" Color	Wired
ZZSENSAL0400AA	Temperature Sensor	None	Wired
ZSENS930AW00MA	Temp & RH Sensor	None	Wireless

Index

Abrasive Pads	34	Channel Nuts	2	Duct Continued	
Access Doors	11	"Cheater" Power Cords	41	Ties	11
Acoustic Duct Liner	10	Check Valves	30	Triangles	10
Acetylene	34	Circuit Breakers	41	Wrap	10
ACR Copper Pipe	32	Cleaning Pads	34	Wyes	15
Add-A-Wire	45	Cleat (Drive and "S")	11	Ductless	
Adhesives	8 - 9	Collars	14	Condensate Pumps & Fittings	30
Air Handler Blocks & Stands	5	Communication Wire	42	Generator-Ready Disconnect	40
Air Pressure Switches	25	Concrete Anchors	6	Linesets & Fittings	32 - 33
All Thread	2	Condensate Pans	5	Wall Mount Bracket	6
Aluminum Repair	34	Condensate Pumps & Switches	30	Wire	42
Aluminum Stands	5 - 7	Condenser Brackets & Cages	6 - 7	Edge Sealer	9
Aluminum Tapes	8	Condenser Pads & Tie Downs	6	Elbows	15
Anchors		Conduit, Bodies, and Clamps	38	Electrical Boxes & Conduit	38
Concrete	6	Concentric Vents	18	Electrical Tape	8
Drywall	9	Connecters & Terminals	43	Energy Recovery Ventilators	20
Threaded Rod	3	Connectors, Duct	14	Equipment Stands	7
Angle Plates	3	Construction Adhesives	9	Exhaust Fans	22 - 24
ArmaFlex® Insulation & Glue	37	Copper Pipe & Fittings	32 - 33	Exhaust Grilles	22
Attic Insulation	11	Cork Tape	8	Exhaust Vents	17
Attic Tent® Enclosures	11	Curb Tape	8	Fasteners	2 - 3, 9
Automotive Fuses	41	Cush Clamps	2	Fans	
B-Vent	18	Dampers		Bath & Exhaust	22 - 24
Backdraft Dampers	16	Blade	14	Inline	22
Ball Valves		Backdraft	16	Rooftop	24
Natural Gas	31	Radiation	23	Fender Washers	2
PVC	28	Zoning	50 - 53	Fire Foam & Caulk	9
Barb Fittings	30	Dehumidifiers		Fittings	
BAS Wire	43	Controls	21	Black Iron	31
Base Rails	5	Duct Adapters	21	Condensate	30
Bath Fans	22 - 23	Commercial Dehumidifiers	21	Copper	32 - 33
Beam Clamps	3	Residential Dehumidifiers	20	PVC	28
Black Pipe & Fittings	31	Diffusers	26	Zoomlock®	32, 35
Blade Fuses	41	Disconnects	39 - 40	Flag Terminals	44
Blown-In Insulation	11	Drain Pans	5	Flame Blankets	34
Bolts	2	Drive Cleat & "Flat S" Cleat	11	Flare Gaskets & Nuts	33
Boots & Bootrail	13, 17	Dryer Boxes & Venting	16 - 17	Flashings	
Boxes		Drywall Anchors & Screws	9	Rooftop	18 - 19
Dryer	16	Duct		Lineset	36
Supply & Return	13 - 14	Access Doors	11	Flat "S" Cleat	11
Brackets, Condenser	6	Board	10	Flat Washers	2
Brazing Gases & Rod	34	Boosters Fans	22	Flex Connectors	14
Brushes		Connectors	14	Flex Duct	10
Mastic	8	Elbows	15	Flexible Conduit	38
Wire	34	Flex Duct & Liner	10	Float Switches	29
Butt Connectors	44	Duct Hanging & Fastening	11	Flux	34
Bypass Dampers	50	Mastic & Sealants	8	Foam Blocks	5
C-Wire Adapter	45	Mixing Boxes	10	Foam Spray & Tape	8 - 9
Cable Hanging Kit	3	Non-Insulated Thermofin®	16	Foil Tapes	8
Cable Ties & Mounts	11, 45	Pipe	11	Fresh Air Ventilation	17, 19
Cages	7	Saddles	25	Furnace Pig Tails	41
Caulk & Caulk Guns	9	Smoke Detection	11	Furnace Stands	5
Caution Tape	8	Strap & Ties	11	Fuse Blocks & Reducers	40
		Supports	11	Fused Disconnects	39
		Tapes	8	Fuses	40 - 41
				Gas Line, Pipe, & Fittings	31

Index Cont.

Gas Valves & Thread Tape	31	Locking Caps	36	Primary Wire	42
Gases, Brazing	34	Loose Fill Insulation	11	Private Label Thermostats	47
Gasket Tape	8	Low-Voltage Circuit Breakers	41	Pumps, Condensate	30
Generator		MAPP Pro Gas	34	PVC Pipe, Fittings, & Glue	28
Generator-Ready Disconnects	40	Masking Tape	8	Radiation Dampers	23
Mounting Pads	6	Masonry Anchors	6	Range Hood Exhaust	17, 24
Pads & Stands	6 - 7	Mastic, Brushes, & Tape	8	Reducers	
Wire	42	Metal Strap	11	Duct / Pipe	15
GFCI Power Cords	41	Mesh & Scrim Tape	8	Fuse	40
Glues		Mini-Split		Reducing Washers	38
ArmaFlex®	8, 37	Condensate Pumps & Fittings	30	Refrigerant Locking Caps	36
Mastic	8	Generator-Ready Disconnect	40	Register Boxes	13 - 14
PVC	28	Linesets & Fittings	32 - 33	Register Screws	9
Goof Plates	45	Wall Mount Bracket	6	Registers (Grilles)	26 - 27
Grilles	26 - 27	Wire	42	Remote Sensors	46 - 47
Grommets	44	Mixing Boxes & Triangles	10	Return Plenums	12
Hanger Strap	11	Mobile Home Flex Duct	10	Ring Terminals	44
Hanging Kits	3	Motorized Dampers	50 - 53	Rod Anchors & Couplers Rod	2 - 3
Hardware & Fasteners	9	Nail Plates	32	Suspension Kit	3
Heat Block	34	Nipples	31	Romex Connectors	38
Heat Shrink Tubing	43	Nitrogen	34	Roof	
Heater Feet	5	"No Hole" Boxes	14	Adhesive	9
Honeywell®		Nuts, Hardware	2	Flashings	18 - 19
Dehumidifiers	20	Nylon Barb Fittings	30	Lineset Jacks	19
RedLINK® & Prestige® IAQ	48 - 51	Nylon Strap	11	Stands	7
Thermostats & Sensors	47 - 49	One-Hole Straps	11, 38	Vents	18 - 19
Zoning	50 - 51	Overflow Switches	29	Rooftop Blocks	3
Hookup Wire	42	Oxygen	34	Rooftop Fans	24
Hose Clamps	30	Pads		RoughinBox	31
Humidity Controls	20	Condenser	6	Safety Switches	29
Hurricane Pads & Tie Downs	6	Generator	6	Safety Tape	8
Inline Fans	22	Vibration	4	Sampling Tubes	25
Inspection Doors	11	Painting Tape	8	Sand Cloth	34
Insulation		Panduit Straps	11, 45	Screws	9
Edge Sealer & Foam	9	Pans, Drain	5	Scrim Tape	8
Flex Duct & Liner	10	Phase Monitors	39	Security Cages	7
Loose Fill	11	Pipe		Self-Tapping Screws	9
Tapes	8	Black Iron	31	Sensors	46 - 49
Armaflex Tubing & Sheets	37	Clamps	2	Shielded Piping Insulation	37
Insulated Pipe Clamps	2	Copper (Soft & ACR)	32	Silicone Caulk	9
Isolators	4	Dope (Sealant)	31	Silver Solder	34
Jones Valve (PVC)	28	Duct (Snaplock)	15	Smoke Detection & Testing	25
Junction Boxes	38	Insulation	37	Snap Collars	14
Kitchen Exhaust	24	Supports	3	Snaplock Pipe	15
Knockout Washers	38	Pre-Insulated Copper	32	Soffit Vents	17
Latex Caulk	9	PVC	28	Solder	34
Line Monitors	39	Tapes	8, 31	Spade Terminals	44
Liner, Duct	10	Plenum Wire	42	Splice Plates & Corners	3
Lineset Covers	36	Plenums	12	Spray Adhesives & Foams	9
Lineset Flashings (Roof)	19	Plumbers Strap	11	Spring Nuts	2
Lineset Flashings (Wall)	36	Polaris™ Connectors	43	Square Washers	2
Lineset Tape & Wrap	8, 37	Pooky	8	Stands, Air Handler	5
Liquid-Tite Conduit & Fittings	38	Power Cords	41	Stands, Condenser	6 - 7
Lock Washers	2	Power Monitors	39	Staple Guns & Staples	10
		Press Fittings	32, 35	Start Collar	14
		Press-On Collars	14	Steel Utility Boxes	38
		Pressure Relief Dampers	50	Storm Collars & Rain Caps	18

Index Cont.

Strap	11
Strut & Strut Hardware	2 - 3
Styrofoam Blocks	5
Submersible Pumps	30
Supply Plenums	12
Surge Arrestors	38
Swivel Flare Adapters	33
System Sensor®	25
Take-Off Collars	14
Tapes	8
Terminal Connectors & Blocks	43
Thermofin® Duct	16
Thermostats	
Add-A-Wire / Wire Saver	45
Cover & Goof Plates	45
Guards	45
Honeywell® Thermostats	47 - 49
PRO1® Thermostats	47
Thermostat Wire	42
Trane® Thermostats	46, 52
Z-Wave Thermostats	46, 48
Thermo-Trap® Heat Past	34
Thread Seal Tape	8, 31
Threaded Rod & Rod Hardware	2 - 3
Threaded Rod Hanging Kit	3
Tie Downs	6
Trane®	
Energy Recovery Ventilators	20
OEM Condenser Mounts	6
Thermostats & Sensors	46, 52
Zoning	52, 53
Transitions	12 - 13
Traps	30
Tread Tape	8
Triangles & Mixing Boxes	10
Trim Plates	45
Tubing	
Copper	32
Heat Shrink	43
Insulation	37
Vinyl	30
UltraLite Pads	6
Unistrut & Unistrut Hardware	2, 3
Utility Boxes & Covers	38
UV Rated Pipe Insulation	32, 37

Vents	
Concentric	18
Dryer	16, 17
Furnace B-Vent	18
Roof	19
Soffit & Wall	17
Vertical Air Handler Stands	5
Vibration Isolators & Pads	4
Vinyl Tubing	30
Voltage Monitors	39
VRF Wire	42
Wall Mount Brackets	6
Wall Plates	45
Wall Sleeves & Flashings	36
Wallstack Duct & Fittings	17
Washers	
Hardware	2
Reducing/Knockout	38
Waterproof Repair Tapes	8
Weatherproof Utility Boxes	38
Webbed Strap	11
Whips, Electrical	38
Wi-Fi Thermostats	46 - 49
Wire	
Brushes	34
Communication	42 - 43
Grommets	45
Hanging & Suspension Kit	3
Hookup	42
Mounts & Clamps	45
Nuts	43
Ties	45
Terminals	43 - 44
Thermostat	42
Wire Saver Module	45
Wrap, Duct	10
Wyes	15
Yellow Gas Line	31
Z-Wave Thermostats	46, 48
Zip Ties	11, 45
Zoning	
Honeywell®	50 - 51
Trane®	52 - 53
ZoomLock® Press Fittings	35
ZoomLock® Push Fittings	32